



# Golf

## Catalog

**EWING**  
OUTDOOR SUPPLY







## A Message from Our President and CEO

Golf is a key part of Ewing Outdoor Supply's success, but our roots in the game run much deeper than mere business. It's part of our DNA.

My grandfather, King W. Ewing, was a caddy and a golf pro long before he began selling and designing irrigation systems in San Francisco in 1938. As Ewing's founder, he took immense pride in helping golf course superintendents create the best playing conditions for their members, including rallying golf and turfgrass associations throughout California to raise money to fund critical turfgrass research beginning in 1951.

King's passion for golf was lifelong. Every generation of our family, from my parents to myself and my brothers, and now our children, has embraced his love of the game as well as his dedication to customer service.

To that end, we've teamed up with valued partners in the golf industry and invested heavily in our golf efforts. We are the exclusive Rain Bird Golf distributor in multiple markets across the country, have opened branches in communities we hadn't previously served and have grown our golf team in a continued quest to ensure that our golf customers have the resources and supplies they need to succeed.

Now in our second century in business, we cannot thank you enough for leaning on us to help you stay on the cutting edge at your courses as the game of golf enjoys a resurgence nationwide. In these pages, you will find the best products the green industry has to offer.

We value the relationships we've built and are building with you, and look forward to strengthening those relationships in the years to come.

Douglas W. York  
President & CEO

# EWING'S PGA TOUR GOLFER PARTNERS



We've partnered with Aaron, Peter, and Steven to elevate awareness of how the behind-the-scenes work on golf courses makes a difference for players. We thank our superintendents for the work you do every day!

## GREAT CONDITIONS REQUIRE THE BEST PARTNERS



**Peter Malnati:**

*"It's been a great start to the partnership and I've been able to have many conversations about Ewing and how them and their products help the conditions of the course we play on day in and day out."*



**Aaron Baddeley:**

*"The continued partnership with Ewing is something I am proud of every time I tee it up. Knowing what the superintendent put into the course to make it great for us, and a company that supports me supports them."*



**Steven Alker:**

*"Ewing is more renowned than even I thought. From the corners of the earth we play on, and amazing facilities that take part on tour...Ewing is there. Can't wait to keep growing their name in the golf world."*



# Ewing Outdoor Supply Golf Catalog

## CONTENTS

- Irrigation** .....4  
Pipe, fittings, hoses and nozzles, swing joints
- Bunker Liners, Drainage and Erosion Control** .....33
- Water Conservation and Technology** ..... 45
- Turf and Ornamental** ..... 48
- Electrical** ..... 54
- Accessories and Tools** ..... 60
- Lake Management** .....67
- Clubhouse** .....69



# Irrigation

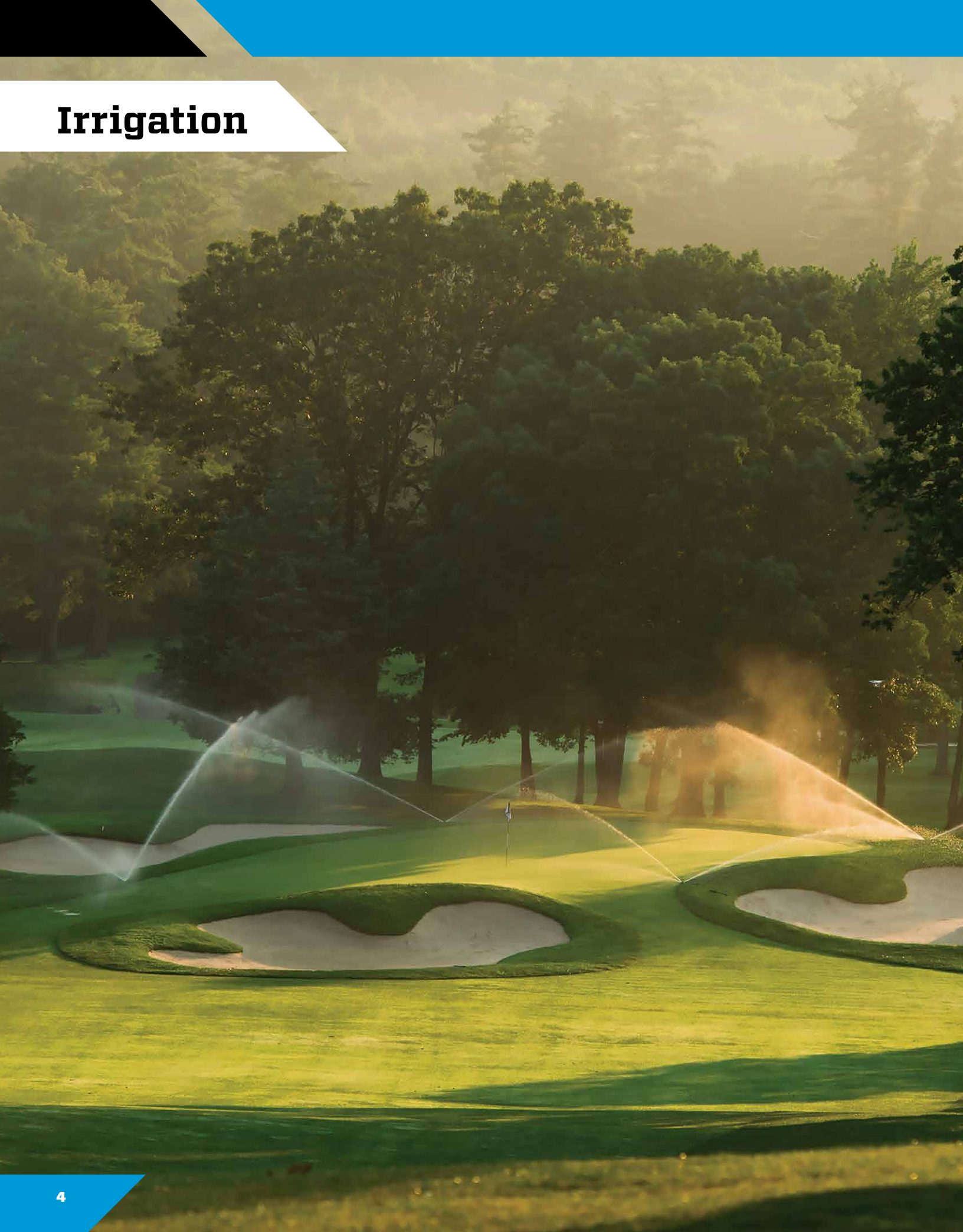



## Rain Bird CirrusPRO™

Go completely mobile with CirrusPRO and get full central control from a mobile device anytime, anywhere, any place. With CirrusPRO, you can make any irrigation changes directly from the map and watch your updates happen in real time.

### FEATURES

**Irrigation that goes where you go:** As the only mobile-first irrigation control system on the market, you get a high level of performance from anywhere on any device.

**More freedom:** Add unlimited users, choose from multiple languages and adjust settings for multiple stations all at once.

**Better data:** Irrigate precisely with real-time data that monitors and notifies about course conditions.

**Complete control:** Water through patented rotation, application, ET and seconds.

| SKU         | Description                                                                         |
|-------------|-------------------------------------------------------------------------------------|
| CIRRUSPRO   | CirrusPRO central control system includes computer and one year of GSP              |
| CIRPROUPG R | Upgrade to CirrusPRO software, includes one year of GSP (payment options available) |



## Rain Bird 552/702/752/952 Series Rotors

Trusted by golf course professionals worldwide, Rain Bird rotors deliver industry-leading durability plus exclusive innovations that make your irrigation more efficient and precise. Rain Bird makes it easier for you to maintain exceptional playing conditions across your entire course – no matter the challenges you face. Plus, every rotor is loaded with benefits you only get from Rain Bird.

### FEATURES

**Consistent uniformity of water applied:** The self-adjusting stator automatically modifies flow to control rotation speed, optimizing performance and providing consistent rotation speed.

**Easy arc adjustments:** Rapid-Adjust Technology allows you to handle arc adjustments with the turn of a screw, while MemoryArc lets you shift between full- and part-circle operation in seconds.

**Performance:** Seal-A-Matic (SAM) built in check valves provide hold back effective up to 17' (5.2m) elevation change.

**Convenience:** Equipped with top serviceable arc adjustments and pressure regulation, as well as easy access to the internal components

| SKU    | Description                                          |
|--------|------------------------------------------------------|
| A552B  | 552 full/part circle block rotor                     |
| A702B  | 702 full circle block rotor                          |
| A702E  | 702 full circle electric rotor (70psi or 80psi)      |
| A702IC | 702 full circle ic rotor (70psi or 80psi)            |
| A752B  | 752 full/part circle block rotor                     |
| A752E  | 752 full/part circle electric rotor (70psi or 80psi) |
| A752IC | 752 full/part circle ic rotor (70psi or 80psi)       |
| 952E   | 952 full/part circle electric rotor (70psi or 80psi) |
| 952IC  | 952 full/part circle ic rotor (70psi or 80psi)       |
| 952SAM | 952 full/part circle sam rotor                       |



## GSV Series Valves

GSV series valves deliver reliable performance you can trust year after year in a full line of plastic options. With industry-leading electrical surge protection and precision pressure regulation pre-installed, the GSV series provides an innovative solution that's strong enough to weather any storm.

### FEATURES

**Unmatched Surge Resistance:** A GBS25 solenoid on electric valves delivers 25kV surge protection

**Adjustable pressure regulation:** Maintain the constant pressure you need between 15 and 100psi, regardless of incoming pressure fluctuations

**Designed to resist chemicals and reclaimed water:** A chlorine-resistant diaphragm delivers increased protection against harsh chemicals

| SKU      | Description                                                  |
|----------|--------------------------------------------------------------|
| GSV100   | 1" golf series NPT electric valve with extra purple handle   |
| GSV150   | 1.5" golf series NPT electric valve with extra purple handle |
| GSV200   | 2" golf series NPT electric valve with extra purple handle   |
| GSVIC100 | 1" golf series NPT IC valve with extra purple handle         |
| GSVIC150 | 1.5" golf series NPT IC valve with extra purple handle       |
| GSVIC200 | 2" golf series NPT IC valve with extra purple handle         |



## Rain Bird IC System™

You can't be everywhere at once. The Integrated Control System (IC System) changed the remote irrigation game and continues to offer intelligent benefits other systems can't match. Connect your Central Control directly to rotors and valves to streamline installations, check diagnostics and troubleshoot from anywhere via smartphone, tablet or computer. Make the smarter choice with IC System™ for powerful, precise property management.

### FEATURES

**Intelligent communication:** In an easy-to-use design, IC CONNECT™ simplifies course management. Collect crucial data from the field and centralize control of greens fans, lighting, fountains and water features.

**Intuitive connection:** Your Central Control directly connects to your rotors and valves and minimizes complexities, simplifies troubleshooting, saves on labor costs and improves aesthetics by eliminating satellites and hubs from your course

**Instant confidence:** Advanced two-way communication from the field to your Central Control catches issues before they become problems and provides assurance your system is working – so you can focus on success.

**Easier to install, simple to maintain:** IC System™ eliminates the most common challenges of traditional systems. Less wire and fewer components means you have less to buy, install, maintain and troubleshoot.

| SKU        | Description                                                      |
|------------|------------------------------------------------------------------|
| A702IC     | 702 full circle IC rotor (70psi or 80psi)                        |
| A752IC     | 752 full/part circle IC rotor (70psi or 80psi)                   |
| A952IC     | 952 full/part circle IC rotor (70psi or 80psi)                   |
| ICMA       | Integrated control module B series valve adapter with O-rings    |
| ICMVLVKIT  | ICM valve kit including ICM and adapter                          |
| ICM        | Integrated control module                                        |
| IC13000120 | IC1+ 2250/3000 (integrated control system plus interface) 120vac |
| ICILINK    | IC1+ link, without radio                                         |
| IC-IN      | IC sensor input device                                           |
| IC-OUT     | IC control output device                                         |
| GSVIC100   | 1" golf series NPT IC valve with extra purple handle             |
| GSVIC150   | 1.5" golf series NPT IC valve with extra purple handle           |
| GSVIC200   | 2" golf series NPT IC valve with extra purple handle             |





## Rain Bird PAR+ES Controller

Boasting advanced technology, PAR+ES satellite controllers feature IFX satellite boards that take communicating with Rain Bird's Integrated Control Interface Plus (ICI+) and IC System™ to the next level.

Now you can upgrade your satellite system using the same wire path while enjoying 72-station capability, unlimited programs with Central Control, premium surge protection, extensive diagnostics and a best-in-class pedestal enclosure. And, with forward-thinking Timeless Compatibility™, it's the best of both worlds for today and tomorrow.

Want even more flexibility? Our exclusive ICI+LINK and LINK 900 MHz radios give you greater design options without the need for additional communication wires or license requirements.

### FEATURES

**Multiple schedule operation:** No schedule limit when operated with Rain Bird Central Control systems. Six automatic (with eight start times each) and two manual schedules available for standalone operation.

**Greater water precision:** Get ample programming and operating control by turning on a maximum of 16 valves at 60 Hz and 12 valves at 50 Hz and features four control modes

**Modular configuration allows easy expansion:** Easily upgrade in eight-station increments. By simply plugging in an eight-station Output Station Module (OSM), you can expand your PAR+ES controller capabilities to accommodate up to 72 stations.

| SKU       | Description                                        |
|-----------|----------------------------------------------------|
| PAR+ES-S  | Standalone controller with switches, gray pedestal |
| PAR+ES-2S | Two-wire controller with switches, gray pedestal   |
| PAR+ES-LS | Link controllers with switches, gray pedestal      |



## Rain Bird Pump Stations

Rain Bird applies its world-leading irrigation expertise to the design and manufacture of golf pump stations. As part of a fully integrated Rain Bird irrigation system, gain real-time response to your pump, monitoring its operation and maximizing flow through the irrigation cycle. You'll get reduced water use, lower energy costs and less wear and tear on your pump station.

### FEATURES

**Designed for durability:** Rain Bird pump stations are built to the highest quality standards, offering enduring performance.

**A fit for any environment or budget:** Every pump station is custom built for the specific requirements of your course.

#### Description

Contact your Ewing rep to custom order



## Rain Bird Golf VB Series Valve Boxes



From durable fabrication to intuitive design features, golf valve boxes are built to a standard the competition can't match.

### FEATURES

**Strength & stability:** Multiple sizes and shapes are designed with corrugated sides and wide-flange bases for maximum durability, compression strength and stability.

**Flexible installations:** Interlocking stacking capabilities, extension models and pipe hole knock-outs support deeper, more flexible installations.

**Smart lid design:** Designed with no holes to keep out pests and beveled edges to minimize potential damage from golf equipment, along with easy hand and shovel access.

**Environmentally friendly:** Earth-conscious, LEED-compliant composition made of 100% recycled materials.

### SPECIFICATIONS

#### 7" Round

- Bottom diameter: 9.9"
- Height: 9"

#### 10" Round

- Bottom diameter: 13.7"
- Height: 10"

#### Standard

- Length x width: 21.8"x 16.6"
- Height: 12"

#### Jumbo

- Length x width: 26.3"x 19.8"
- Height: 12.1"

| SKU        | Description                        |
|------------|------------------------------------|
| GVB7RNDGR  | 7" round with a green lid          |
| GVB7RNDBLK | 7" round with a black lid          |
| GVB7RNDPUR | 7" round with a purple lid         |
| GVB7RNDTAN | 7" round with a tan lid            |
| GVB10RNDGR | 10" round with a green lid         |
| GVB10RNDBL | 10" round with a black lid         |
| GVB10RNDPU | 10" round with a purple lid        |
| GVB10RNDTA | 10" round with a tan lid           |
| GVBSTDGR   | Standard valve box with green lid  |
| GVBSTDBLK  | Standard valve box with black lid  |
| GVBSTDPURP | Standard valve box with purple lid |
| GVBSTDOTAN | Standard valve box with tan lid    |
| GVBJMBGR   | Jumbo valve box with green lid     |
| GVBJMBBLK  | Jumbo valve box with black lid     |
| GVBJMBPURP | Jumbo valve box with purple lid    |
| GVBJMBTAN  | Jumbo valve box with tan lid       |



## Rain Bird Golf Swing Joints

Designed to deliver the performance you expect while saving you money with their superior flow characteristics and excellent structural integrity. Available in a wide range of configurations, Rain Bird swing joints are the perfect complement to our golf series rotors.

### FEATURES

**Reduce pressure loss by up to 50%:** An innovative swept elbow design reduces turbulence significantly which reduces pressure loss by up to 50%, increasing pump efficiency.

**Dependable performance:** Double O-ring protection provides a better seal to ensure that joints are kept clean and can be repositioned easily.

**Keeps you out of harms way:** Our modified ACME outlet disengages the seal before disengaging the threads, preventing a worker from accidentally unthreading a rotor from a pressurized line.

**Extended warranty:** When used with Rain Bird golf rotors, extend rotor and swing joint warranty to five years.

### SPECIFICATIONS

- Length: 8", 12", 18"
- Diameter: 1", 1.25", 1.5"
- Inlet/outlet style: NPT, ACME, spigot, reducing/enlarging ACME
- Options: Top mount inlet, triple top outlet

| SKU         | Description                                               |
|-------------|-----------------------------------------------------------|
| SJ08100XXXX | 8" lay arm, 1" diameter, must choose inlet and outlet     |
| SJ08125XXXX | 8" lay arm, 1.25" diameter, must choose inlet and outlet  |
| SJ08150XXXX | 8" lay arm, 1.50" diameter, must choose inlet and outlet  |
| SJ12100XXXX | 12" lay arm, 1" diameter, must choose inlet and outlet    |
| SJ12125XXXX | 12" lay arm, 1.25" diameter, must choose inlet and outlet |
| SJ12150XXXX | 12" lay arm, 1.50" diameter, must choose inlet and outlet |
| SJ18100XXXX | 18" lay arm, 1" diameter, must choose inlet and outlet    |
| SJ18125XXXX | 18" lay arm, 1.25" diameter, must choose inlet and outlet |
| SJ18150XXXX | 18" lay arm, 1.50" diameter, must choose inlet and outlet |

# What Our Customers Say



## The Apawamis Club

Rye, New York

“At the end of the day, the decision to partner with Rain Bird, was a pretty easy one. The combination of industry-leading innovation; reliability and ease of use, help to expedite the process of building, scheduling and running programs. Ultimately, I can sleep better at night, knowing that irrigation functionality is one less thing that I need to worry about.”

—Jace Roman, Head Golf Course Superintendent



## Somerset Hills Country Club

Bernardsville, New Jersey

“Rain Bird Central Control is simple and easy to navigate, while giving you the ability to micromanage water and create intricate new programs on the fly. I can take water management to another level. We are putting water exactly where we want it, when we want it and in the appropriate quantities.”

—Ryan Tuxhorn, Golf Course Superintendent



## Deerefield Golf & Country Club

Brockport, NY

“We are a course that understands the importance of constantly improving. There were two deciding factors for selecting Rain Bird. The first was the ease of adding to the Rain Bird IC System™. The other deciding factor, and just as important, was the product support, of my primarily my salesman Alex Ludwig, and Rain Bird's GSP Team.”

—Nick Pentz, Superintendent



# Your Trusted Source for Quality High-Density Polyethylene (HDPE) Piping Solutions



## HDPE PRODUCTS

- Pipe
- Fittings
- Ball Valves
- Gate Valves

## HDPE SERVICES

- McElroy Fusion Equipment for Rent and Purchase
- Custom Fabrication
- Technical Support
- Certification Training



Contact your Ewing rep for more information.

## PVC Pressure Pipe SCH-40 and SCH-80

| <b>SCH-40</b><br>PRESSURE PIPE<br>PVC1120<br>ASTM<br>D1785<br><br> | SIZE   | O.D.   | MIN. WALL | WEIGHT PER 100' | SOCKET DEPTH INCHES | FEET PER PALLET | PALLETS PER T.L. | BELLED PART NO. |
|-----------------------------------------------------------------------------------------------------------------------------------------------------|--------|--------|-----------|-----------------|---------------------|-----------------|------------------|-----------------|
|                                                                                                                                                     | 1/2"   | .840   | .109      | 16.18           | 2.000               | 8400            | 44               | 42015           |
|                                                                                                                                                     | 3/4    | 1.050  | .113      | 21.58           | 2.125               | 6600            | 40               | 42030           |
|                                                                                                                                                     | 1      | 1.315  | .133      | 32.00           | 2.375               | 5400            | 32               | 42046           |
|                                                                                                                                                     | 1 1/4  | 1.660  | .140      | 43.40           | 2.750               | 4000            | 32               | 42056           |
|                                                                                                                                                     | 1 1/2  | 1.900  | .145      | 51.83           | 3.000               | 3600            | 28               | 42070           |
|                                                                                                                                                     | 2      | 2.375  | .154      | 69.71           | 3.000               | 2800            | 24               | 42085           |
|                                                                                                                                                     | 2 1/2  | 2.875  | .203      | 110.57          | 3.500               | 2240            | 20               | 42102           |
|                                                                                                                                                     | 3      | 3.500  | .216      | 144.82          | 4.000               | 1500            | 20               | 42111           |
|                                                                                                                                                     | 4      | 4.500  | .237      | 213.29          | 5.000               | 580             | 28               | 47675           |
|                                                                                                                                                     | 6      | 6.625  | .280      | 375.79          | 6.500               | 400             | 20               | 47720           |
|                                                                                                                                                     | 8      | 8.625  | .332      | 582.30          | 7.000               | 280             | 16               | 47735           |
|                                                                                                                                                     | 10     | 10.750 | .365      | 803.40          | 7.500               | 160             | 16               | 47745           |
|                                                                                                                                                     | 12     | 12.750 | .406      | 1064.45         | 8.000               | 120             | 12               | 47756           |
| 16                                                                                                                                                  | 16.000 | .500   | 1658.84   | 10.000          | 120                 | 12              | 47775            |                 |

STANDARD LENGTH 20' EXCEPT 4", 6", 8", 10", 12" & 16" WHICH ARE 20' LAYING LENGTH. NOT RECOMMENDED FOR THREADING.

SCH-80 PIPE IS FURNISHED IN PLAIN END (PE) 20' LENGTHS.

|                                                                                                                                                       |       |        |      |         |    |      |    |       |
|-------------------------------------------------------------------------------------------------------------------------------------------------------|-------|--------|------|---------|----|------|----|-------|
| <b>SCH-80</b><br>PRESSURE PIPE<br>PVC1120<br>ASTM<br>D1785<br><br> | 1/2"  | .840   | .147 | 20.63   | PE | 5200 | 60 | 43010 |
|                                                                                                                                                       | 3/4   | 1.050  | .154 | 28.02   | PE | 4400 | 48 | 43025 |
|                                                                                                                                                       | 1     | 1.315  | .179 | 41.23   | PE | 5200 | 32 | 43045 |
|                                                                                                                                                       | 1 1/4 | 1.660  | .191 | 57.06   | PE | 4000 | 32 | 43065 |
|                                                                                                                                                       | 1 1/2 | 1.900  | .200 | 69.19   | PE | 2360 | 40 | 43080 |
|                                                                                                                                                       | 2     | 2.375  | .218 | 95.89   | PE | 1860 | 32 | 43095 |
|                                                                                                                                                       | 2 1/2 | 2.875  | .276 | 146.24  | PE | 1160 | 36 | 43115 |
|                                                                                                                                                       | 3     | 3.500  | .300 | 195.88  | PE | 1500 | 20 | 43120 |
|                                                                                                                                                       | 4     | 4.500  | .337 | 286.26  | PE | 580  | 28 | 43135 |
|                                                                                                                                                       | 6     | 6.625  | .432 | 546.56  | PE | 400  | 20 | 43150 |
|                                                                                                                                                       | 8     | 8.625  | .500 | 830.24  | PE | 280  | 16 | 43165 |
|                                                                                                                                                       | 10    | 10.750 | .593 | 1230.78 | PE | 160  | 16 | 43170 |
|                                                                                                                                                       | 12    | 12.750 | .687 | 1692.06 | PE | 120  | 12 | 43175 |

SCH-80 PIPE IS RECOMMENDED FOR THREADING.

**CRESLINE-WEST®**

## PVC Pressure Pipe SCH-40 and SCH-80 (cont.)

### PRESSURE RATINGS FOR CRESLINE - PVC PIPES AT 73.4° F

| SIZE   | 1/2 | 3/4 | 1   | 1 1/4 | 1 1/2 | 2   | 2 1/2 | 3   | 4   | 6   | 8   | 10  | 12  | 16  |
|--------|-----|-----|-----|-------|-------|-----|-------|-----|-----|-----|-----|-----|-----|-----|
| SCH-40 | 600 | 480 | 450 | 370   | 330   | 280 | 300   | 260 | 220 | 180 | 160 | 140 | 130 | 130 |
| SCH-80 | 850 | 690 | 630 | 520   | 470   | 400 | 420   | 370 | 320 | 280 | 250 | 230 | 230 | -   |

### CONVERSION CHART FOR PRESSURE RATINGS AT VARIOUS TEMPERATURES FOR CRESLINE - PVC PIPE

| TEMPERATURE °F    | 73.4° | 80° | 90° | 100° | 110° | 120° | 130° | 140° |
|-------------------|-------|-----|-----|------|------|------|------|------|
| CONVERSION FACTOR | 1.00  | .88 | .75 | .62  | .50  | .40  | .30  | .22  |

PRESSURE RATING IS THE ESTIMATED MAXIMUM PRESSURE THAT WATER AS THE MEDIUM IN THE PIPE CAN EXERT CONTINUOUSLY WITH A HIGH DEGREE OF CERTAINTY THAT FAILURE OF THE PIPE WILL NOT OCCUR.

**DO NOT USE PLASTIC PIPE AND FITTINGS FOR COMPRESSED AIR.**

### PALLET QUANTITY PVC PRESSURE PIPE

| PIPE SIZE | FEET PER PALLET | WT. PER PALLET |
|-----------|-----------------|----------------|
|           |                 | SCH-40         |
| 1/2"      | 8400            | 1360           |
| 3/4       | 6600            | 1425           |
| 1         | 5400            | 1728           |
| 1 1/4     | 4000            | 1736           |
| 1 1/2     | 3600            | 1866           |
| 2         | 2800            | 1952           |
| 2 1/2     | 2240            | 2477           |
| 3         | 1500            | 2173           |
| 4         | 580             | 1238           |
| 6         | 400             | 1504           |
| 8         | 280             | 1631           |
| 10        | 160             | 1286           |
| 12        | 120             | 1278           |
| 16        | 120             | 1991           |

| PIPE SIZE | FEET PER PALLET | WT. PER PALLET |
|-----------|-----------------|----------------|
|           |                 | SCH-80         |
| 1/2"      | 5200            | 1073           |
| 3/4       | 4400            | 1233           |
| 1         | 5200            | 2144           |
| 1 1/4     | 4000            | 2283           |
| 1 1/2     | 2360            | 1633           |
| 2         | 1860            | 1784           |
| 2 1/2     | 1160            | 1697           |
| 3         | 1500            | 2939           |
| 4         | 580             | 1661           |
| 6         | 400             | 2187           |
| 8         | 280             | 2325           |
| 10        | 160             | 1970           |
| 12        | 120             | 2031           |

## PVC Pressure Pipe - SDR-26 and SDR-21

| <b>SDR-26</b><br><b>PRESSURE PIPE</b><br><b>160 PSI</b><br><b>PVC1120</b><br><b>ASTM D2241</b><br> | SIZE   | O.D.   | MIN. WALL | WEIGHT PER 100' | SOCKET DEPTH INCHES | FEET PER PALLET | PALLETS PER T.L. | BELLED PART NO. |
|-------------------------------------------------------------------------------------------------------------------------------------------------------------------------------------|--------|--------|-----------|-----------------|---------------------|-----------------|------------------|-----------------|
|                                                                                                                                                                                     | 1¼"    | 1.660  | .064      | 20.93           | 2.750               | 4000            | 32               | 45243           |
|                                                                                                                                                                                     | 1½     | 1.900  | .073      | 27.31           | 3.000               | 3600            | 28               | 45280           |
|                                                                                                                                                                                     | 2      | 2.375  | .091      | 42.51           | 3.000               | 2800            | 24               | 45345           |
|                                                                                                                                                                                     | 2½     | 2.875  | .110      | 62.13           | 3.500               | 2240            | 20               | 45410           |
|                                                                                                                                                                                     | 3      | 3.500  | .135      | 92.81           | 4.000               | 1500            | 20               | 45470           |
|                                                                                                                                                                                     | 4      | 4.500  | .173      | 156.97          | 5.000               | 580             | 28               | 47075           |
|                                                                                                                                                                                     | 6      | 6.625  | .255      | 342.71          | 6.500               | 400             | 20               | 47120           |
|                                                                                                                                                                                     | 8      | 8.625  | .332      | 581.78          | 7.000               | 280             | 16               | 47735           |
|                                                                                                                                                                                     | 10     | 10.750 | .413      | 904.15          | 7.500               | 160             | 16               | 47145           |
|                                                                                                                                                                                     | 12     | 12.750 | .490      | 1274.47         | 8.000               | 120             | 12               | 47155           |
| 16                                                                                                                                                                                  | 16.000 | .616   | 2026.31   | 10.000          | 120                 | 12              | 47175            |                 |

NOTE: 8" SDR-26 IS DUAL MARKED FOR SCH-40 PIPE.

| <b>SDR-21</b><br><b>PRESSURE PIPE</b><br><b>200 PSI</b><br><b>PVC1120</b><br><b>ASTM D2241</b><br> | SIZE   | O.D.   | MIN. WALL | WEIGHT PER 100' | SOCKET DEPTH INCHES | FEET PER PALLET | PALLETS PER T.L. | BELLED PART NO. |
|---------------------------------------------------------------------------------------------------------------------------------------------------------------------------------------|--------|--------|-----------|-----------------|---------------------|-----------------|------------------|-----------------|
|                                                                                                                                                                                       | *½"    | .840   | .062      | 9.81            | 2.000               | 8400            | 44               | 46105           |
|                                                                                                                                                                                       | ¾      | 1.050  | .060      | 12.11           | 2.125               | 6600            | 40               | 46157           |
|                                                                                                                                                                                       | 1      | 1.315  | .063      | 16.17           | 2.375               | 5400            | 32               | 46207           |
|                                                                                                                                                                                       | 1¼     | 1.660  | .079      | 25.59           | 2.750               | 4000            | 32               | 46243           |
|                                                                                                                                                                                       | 1½     | 1.900  | .090      | 33.32           | 3.000               | 3600            | 28               | 46285           |
|                                                                                                                                                                                       | 2      | 2.375  | .113      | 52.32           | 3.000               | 2800            | 24               | 46345           |
|                                                                                                                                                                                       | 2½     | 2.875  | .137      | 76.53           | 3.500               | 2240            | 20               | 46410           |
|                                                                                                                                                                                       | 3      | 3.500  | .167      | 113.71          | 4.000               | 1500            | 20               | 46470           |
|                                                                                                                                                                                       | 4      | 4.500  | .214      | 192.22          | 5.000               | 580             | 28               | 47275           |
|                                                                                                                                                                                       | 6      | 6.625  | .316      | 420.11          | 6.500               | 400             | 20               | 47320           |
|                                                                                                                                                                                       | 8      | 8.625  | .410      | 710.96          | 7.500               | 280             | 16               | 47335           |
|                                                                                                                                                                                       | 10     | 10.750 | .511      | 1106.58         | 8.000               | 160             | 16               | 47355           |
| 12                                                                                                                                                                                    | 12.750 | .606   | 1560.36   | 10.000          | 120                 | 12              | 47375            |                 |

\*SDR 13.5 - 315 PSI. NOT RECOMMENDED FOR THREADING.

STANDARD LENGTH 20' EXCEPT 4", 6", 8", 10", 12", & 16" WHICH ARE 20' LAYING LENGTH.

**CRESLINE-WEST®**

## PVC Pressure Pipe - SDR-26 and SDR-21 (cont.)

### PRESSURE RATINGS FOR CRESLINE - PVC PIPES AT 73.4° F

| SIZE   | ½   | ¾   | 1   | 1¼  | 1½  | 2   | 2½  | 3   | 4   | 6   | 8   | 10  | 12  | 16  |
|--------|-----|-----|-----|-----|-----|-----|-----|-----|-----|-----|-----|-----|-----|-----|
| SDR-26 | --  | --  | --  | 160 | 160 | 160 | 160 | 160 | 160 | 160 | 160 | 160 | 160 | 160 |
| SDR-21 | 315 | 200 | 200 | 200 | 200 | 200 | 200 | 200 | 200 | 200 | 200 | 200 | 200 | --  |

### CONVERSION CHART FOR PRESSURE RATINGS AT VARIOUS TEMPERATURES FOR CRESLINE - PVC PIPE

| TEMPERATURE °F    | 73.4° | 80° | 90° | 100° | 110° | 120° | 130° | 140° |
|-------------------|-------|-----|-----|------|------|------|------|------|
| CONVERSION FACTOR | 1.00  | .88 | .75 | .62  | .50  | .40  | .30  | .22  |

PRESSURE RATING IS THE ESTIMATED MAXIMUM PRESSURE THAT WATER AS THE MEDIUM IN THE PIPE CAN EXERT CONTINUOUSLY WITH A HIGH DEGREE OF CERTAINTY THAT FAILURE OF THE PIPE WILL NOT OCCUR.

**DO NOT USE PLASTIC PIPE AND FITTINGS FOR COMPRESSED AIR.**

#### PALLET QUANTITY PVC PRESSURE PIPE

| PIPE SIZE | FEET PER PALLET | WT. PER PALLET |        |
|-----------|-----------------|----------------|--------|
|           |                 | SDR-26         | SDR-21 |
| ½         | 8400            | --             | 824    |
| ¾         | 6600            | --             | 799    |
| 1         | 5400            | --             | 873    |
| 1¼        | 4000            | 837            | 1024   |
| 1½        | 3600            | 983            | 1200   |
| 2         | 2800            | 1191           | 1465   |
| 2½        | 2240            | 1392           | 1714   |
| 3         | 1500            | 1392           | 1706   |
| 4         | 580             | 910            | 1115   |
| 6         | 400             | 1371           | 1681   |
| 8         | 280             | 1629           | 1991   |
| 10        | 160             | 1447           | 1771   |
| 12        | 120             | 1529           | 1872   |
| 16        | 120             | 2432           | --     |

#### PVC SDR-26 & SDR-21 CAN BE USED ON JET OR SUBMERSIBLE PUMPS OF 1HP OR LESS

| MAXIMUM DEPTH SETTING TO WATER LEVEL IN FT @ 73.4° F |                             |        |        |
|------------------------------------------------------|-----------------------------|--------|--------|
| CRESLINE PVC<br>PRESSURE PIPE                        | MAX. TANK SHUT-OFF PRESSURE |        |        |
|                                                      | 40 PSI                      | 50 PSI | 60 PSI |
| ANY SIZE PVC SDR-26                                  | 275'                        | 255'   | 230'   |
| ANY SIZE PVC SDR-21                                  | 365'                        | 345'   | 320'   |



## PVC Pressure Pipe Gasket Joint

| <b>GASKET JOINT<br/>SDR-26</b><br>PRESSURE PIPE<br>160 PSI<br>PVC1120<br>ASTM D2241<br><br> | SIZE | O.D.   | MIN.<br>WALL | WEIGHT<br>PER<br>100' | SOCKET<br>DEPTH<br>INCHES | FEET<br>PER<br>PALLET | PALLETS<br>PER<br>T.L. | GJ<br>PART<br>NO. |
|------------------------------------------------------------------------------------------------------------------------------------------------------------------------------|------|--------|--------------|-----------------------|---------------------------|-----------------------|------------------------|-------------------|
|                                                                                                                                                                              | 2    | 2.375  | .091         | 43.44                 | 4.25                      | 2960                  | 20                     | 48070             |
|                                                                                                                                                                              | 2½   | 2.875  | .110         | 63.63                 | 4.75                      | 1800                  | 20                     | 48090             |
|                                                                                                                                                                              | 3    | 3.500  | .135         | 95.24                 | 5.00                      | 1160                  | 20                     | 48110             |
|                                                                                                                                                                              | 4    | 4.500  | .173         | 157.63                | 6.00                      | 760                   | 20                     | 48130             |
|                                                                                                                                                                              | 6    | 6.625  | .255         | 343.09                | 6.75                      | 360                   | 20                     | 48170             |
|                                                                                                                                                                              | 8    | 8.625  | .332         | 585.35                | 8.00                      | 280                   | 16                     | 48190             |
|                                                                                                                                                                              | 10   | 10.750 | .413         | 909.60                | 8.75                      | 160                   | 16                     | 48200             |
|                                                                                                                                                                              | 12   | 12.750 | .490         | 1280.80               | 9.50                      | 120                   | 12                     | 48210             |

|                                                                                                                                                                                |    |        |      |         |      |      |    |       |
|--------------------------------------------------------------------------------------------------------------------------------------------------------------------------------|----|--------|------|---------|------|------|----|-------|
| <b>GASKET JOINT<br/>SDR-21</b><br>PRESSURE PIPE<br>200 PSI<br>PVC1120<br>ASTM D2241<br><br> | 2  | 2.375  | .113 | 53.46   | 4.25 | 2960 | 20 | 48471 |
|                                                                                                                                                                                | 2½ | 2.875  | .137 | 78.37   | 4.75 | 1800 | 20 | 48491 |
|                                                                                                                                                                                | 3  | 3.500  | .167 | 116.68  | 5.00 | 1160 | 20 | 48511 |
|                                                                                                                                                                                | 4  | 4.500  | .214 | 193.02  | 6.00 | 760  | 20 | 48531 |
|                                                                                                                                                                                | 6  | 6.625  | .316 | 420.57  | 6.75 | 360  | 20 | 48571 |
|                                                                                                                                                                                | 8  | 8.625  | .410 | 715.32  | 8.00 | 280  | 16 | 48591 |
|                                                                                                                                                                                | 10 | 10.750 | .511 | 1113.26 | 8.75 | 160  | 16 | 48600 |
|                                                                                                                                                                                | 12 | 12.750 | .606 | 1568.19 | 9.50 | 120  | 12 | 48610 |

20 FT. LAYING LENGTH ± 1".

GASKET JOINT PIPE IS PRODUCED FROM PVC MATERIAL AS PER ASTM D1784.

GASKET JOINT PIPE IS PRODUCED WITH AN INTEGRAL BELL END WITH A REINFORCED GASKET CONFORMING TO ASTM F477.

**CRESLINE-WEST®**

**PVC Pressure Pipe Gasket Joint (cont.)**

CONVERSION CHART FOR PRESSURE RATINGS  
AT VARIOUS TEMPERATURES FOR CRESLINE - PVC PIPE

|                   |       |     |     |      |      |      |      |      |
|-------------------|-------|-----|-----|------|------|------|------|------|
| TEMPERATURE °F    | 73.4° | 80° | 90° | 100° | 110° | 120° | 130° | 140° |
| CONVERSION FACTOR | 1.00  | .88 | .75 | .62  | .50  | .40  | .30  | .22  |

PRESSURE RATING IS THE ESTIMATED MAXIMUM PRESSURE THAT WATER AS THE MEDIUM IN THE PIPE CAN EXERT CONTINUOUSLY WITH A HIGH DEGREE OF CERTAINTY THAT FAILURE OF THE PIPE WILL NOT OCCUR.

**DO NOT USE PLASTIC PIPE AND FITTINGS FOR COMPRESSED AIR.**

ASSEMBLY:

- CLEAN AND DRY THE INTERIOR OF GASKET BELL AND THE EXTERIOR OF THE PIPE SPIGOT.
- APPLY LUBRICANT TO THE SPIGOT END OF THE PIPE. LUBRICATE UP TO THE INSERTION DEPTH RING. DO NOT LUBRICATE THE GASKET.
- INSERT THE SPIGOT END INTO THE GASKET BELL, MAKING SURE THE TWO LENGTHS ARE ALIGNED. PUSH THE PIPES TOGETHER UNTIL THE SPIGOT DEPTH RING IS FLUSH WITH THE ENTRANCE OF THE BELL.

PRECAUTIONS:

- BE SURE TO KEEP DIRT OFF LUBRICATED SPIGOT AND OUT OF THE GASKET BELL.
- THE PIPE SHOULD BE BURIED AT LEAST 24 INCHES BELOW GROUND AND PREFERABLY BELOW THE FROST LINE.
- INSTALLATION, TRENCHING, THRUST BLOCKING AND BACKFILLING SHOULD BE PERFORMED IN ACCORDANCE WITH ASTM D2774.
- BE SURE LINE IS PRESSURE TESTED BEFORE BACKFILLING. PIPE SHALL BE ADEQUATELY ANCHORED TO PREVENT MOVEMENT. THE JOINTS AND FITTINGS SHALL REMAIN EXPOSED TO FACILITATE INSPECTION FOR JOINT LEAKAGE.

PALLET QUANTITIES GJ PVC PRESSURE PIPE

| PIPE SIZE | FEET PER PALLET | WT. PER PALLET |        |
|-----------|-----------------|----------------|--------|
|           |                 | SDR-26         | SDR-21 |
| 2         | 2960            | 1190           | 1465   |
| 2½        | 1800            | 1392           | 1715   |
| 3         | 1160            | 1393           | 1706   |
| 4         | 760             | 918            | 1115   |
| 6         | 360             | 1374           | 1680   |
| 8         | 280             | 1552           | 1991   |
| 10        | 160             | 1456           | 1782   |
| 12        | 120             | 1537           | 1882   |

GJ BELL DIMENSIONS

| PIPE SIZE | SOCKET ENTRANCE LGTH. | SOCKET LENGTH |
|-----------|-----------------------|---------------|
| 2         | .750                  | 4.250         |
| 2½        | .875                  | 4.750         |
| 3         | .875                  | 5.000         |
| 4         | 1.250                 | 6.000         |
| 6         | 1.375                 | 6.750         |
| 8         | 1.750                 | 8.000         |
| 10        | 2.000                 | 8.750         |
| 12        | 2.250                 | 9.500         |

JOINTS INSTALLED PER QUART OF LUBRICANT

| PIPE SIZE | JOINTS |
|-----------|--------|
| 2         | 125    |
| 3         | 105    |
| 4         | 100    |
| 6         | 70     |
| 8         | 50     |
| 10        | 8      |
| 12        | 6      |

## PVC-PSM Sewer Pipe

| GASKET JOINT<br>PSM SEWER PIPE<br>SDR-35<br>ASTM D3034 | SIZE   | O.D.  | MIN.<br>WALL | WEIGHT<br>PER<br>100' | FEET<br>PER<br>PALLET | PALLETS<br>PER<br>T.L. | LGTH. | PART<br>NO. |
|--------------------------------------------------------|--------|-------|--------------|-----------------------|-----------------------|------------------------|-------|-------------|
|                                                        | 4"     | 4.215 | .120         | 109.04                | 1260                  | 18                     | 14'   | 53726       |
|                                                        |        |       | 108.05       | 1200                  | 16                    | 20                     | 53735 |             |
| 6                                                      | 6.275  | .180  | 244.06       | 490                   | 18                    | 14                     | 53786 |             |
|                                                        |        |       | 241.84       | 700                   | 12                    | 20                     | 53795 |             |
| 8                                                      | 8.400  | .240  | 438.52       | 280                   | 18                    | 14                     | 53806 |             |
|                                                        |        |       | 433.62       | 400                   | 12                    | 20                     | 53815 |             |
| 10                                                     | 10.500 | .300  | 685.91       | 168                   | 18                    | 14                     | 53826 |             |
| 12                                                     | 12.500 | .360  | 980.09       | 112                   | 24                    | 14                     | 53836 |             |

|                                                        |    |        |      |         |      |    |     |       |
|--------------------------------------------------------|----|--------|------|---------|------|----|-----|-------|
| GASKET JOINT<br>PSM SEWER PIPE<br>SDR-26<br>ASTM D3034 | 4" | 4.215  | .162 | 145.64  | 1260 | 18 | 14' | 53506 |
|                                                        | 6  | 6.275  | .241 | 323.01  | 490  | 18 | 14  | 53526 |
|                                                        | 8  | 8.400  | .323 | 583.79  | 280  | 18 | 14  | 53550 |
|                                                        | 10 | 10.500 | .404 | 913.21  | 168  | 18 | 14  | 53531 |
|                                                        | 12 | 12.500 | .481 | 1290.43 | 112  | 24 | 14  | 53541 |

14' & 20' LAYING LENGTHS. INSERTION DEPTH RING IS MARKED ON THE SPIGOT END OF PIPE.

GASKET JOINT PIPE IS PRODUCED WITH AN INTEGRAL BELL END WITH A REINFORCED GASKET CONFORMING TO ASTM F477.

|                                                        |    |       |      |        |      |    |     |       |
|--------------------------------------------------------|----|-------|------|--------|------|----|-----|-------|
| SOLVENT WELD<br>PSM SEWER PIPE<br>SDR-35<br>ASTM D3034 | 4" | 4.215 | .120 | 105.74 | 900  | 24 | 10' | 53115 |
|                                                        |    |       |      |        | 1200 | 16 | 20  | 53118 |
|                                                        | 6  | 6.275 | .180 | 236.66 | 350  | 24 | 10  | 53180 |
|                                                        |    |       |      |        | 700  | 12 | 20  | 53183 |
|                                                        | 8  | 8.400 | .240 | 422.19 | 200  | 16 | 10  | 53250 |

|                                                        |    |       |      |        |      |    |     |       |
|--------------------------------------------------------|----|-------|------|--------|------|----|-----|-------|
| SOLVENT WELD<br>PSM SEWER PIPE<br>SDR-26<br>ASTM D3034 | 4" | 4.215 | .162 | 141.23 | 900  | 24 | 10' | 53416 |
|                                                        |    |       |      |        | 1200 | 16 | 20  | 53425 |
|                                                        | 6  | 6.275 | .241 | 313.22 | 350  | 18 | 10  | 53455 |

PERFORATED SOLVENT WELD PSM SEWER PIPE IS AVAILABLE.

**CRELINE-WEST®**

## PVC Schedule 40 Electrical Conduit

| <b>PVC SCH 40</b><br><br><b>RIGID</b><br><br><b>ELECTRICAL CONDUIT</b><br><br> | SIZE  | O.D.  | I.D.  | MIN. WALL | WEIGHT PER 100' | FEET PER PALLET | BELL END LGTH. | PART NO. |
|-----------------------------------------------------------------------------------------------------------------------------------------------------------------|-------|-------|-------|-----------|-----------------|-----------------|----------------|----------|
|                                                                                                                                                                 | 1/2"  | .840  | .622  | .109      | 16.12           | 3000            | 10'            | 58015    |
|                                                                                                                                                                 | 3/4   | 1.050 | .824  | .113      | 21.50           | 4400            | 10'            | 58025    |
|                                                                                                                                                                 | 1     | 1.315 | 1.049 | .133      | 31.89           | 3600            | 10'            | 58035    |
|                                                                                                                                                                 |       |       |       |           |                 | 7200            | 20'            | 58030    |
|                                                                                                                                                                 | 1 1/4 | 1.660 | 1.380 | .140      | 43.24           | 2000            | 10'            | 58047    |
|                                                                                                                                                                 |       |       |       |           |                 | 4000            | 20'            | 58042    |
|                                                                                                                                                                 | 1 1/2 | 1.900 | 1.610 | .145      | 51.65           | 2250            | 10'            | 58055    |
|                                                                                                                                                                 |       |       |       |           |                 | 4500            | 20'            | 58050    |
|                                                                                                                                                                 | 2     | 2.375 | 2.067 | .154      | 69.85           | 1400            | 10'            | 58065    |
| 2800                                                                                                                                                            |       |       |       |           |                 | 20'             | 58060          |          |
| 2 1/2                                                                                                                                                           | 2.875 | 2.469 | .203  | 110.80    | 930             | 10'             | 58075          |          |
|                                                                                                                                                                 |       |       |       |           | 1860            | 20'             | 58070          |          |
| 3                                                                                                                                                               | 3.500 | 3.068 | .216  | 145.13    | 880             | 10'             | 58085          |          |
|                                                                                                                                                                 |       |       |       |           | 1760            | 20'             | 58080          |          |
| 4                                                                                                                                                               | 4.500 | 4.026 | .237  | 206.63    | 570             | 10'             | 58095          |          |
|                                                                                                                                                                 |       |       |       |           | 1140            | 20'             | 58090          |          |

PVC SCH 40 ELECTRICAL CONDUIT IS PRODUCED IN 10' & 20' LENGTHS WITH BELL END.

PVC SCH 40 ELECTRICAL CONDUIT IS GRAY IN COLOR.

PVC SCH 40 ELECTRICAL CONDUIT CONFORMS TO: UL 651 INCLUDING 90° C RATING  
NEMA TC 2  
SUNLIGHT RESISTANT

| % OF TRUCKLOAD PER PALLET |                   |                   |
|---------------------------|-------------------|-------------------|
| SIZE                      | %/TL<br>10' LGTH. | %/TL<br>20' LGTH. |
| 1/2                       | 0.9               | —                 |
| 3/4                       | 2.1               | —                 |
| 1                         | 1.7               | 3.4               |
| 1 1/4                     | 2.3               | 4.6               |
| 1 1/2                     | 2.5               | 5.0               |
| 2                         | 2.1               | 4.2               |
| 2 1/2                     | 2.3               | 4.6               |
| 3                         | 2.9               | 5.8               |
| 4                         | 3.0               | 6.0               |

## PVC Purple Reclaimed Water Pipe

| SDR-21<br>SOLVENT WELD<br>RECLAIMED WATER PIPE<br>200 PSI<br>PVC1120<br>ASTM D2241 | SIZE  | O.D. | MIN.<br>WALL | WEIGHT<br>PER<br>100' | SOCKET<br>DEPTH<br>INCHES | FEET<br>PER<br>PALLET | PALLETS<br>PER<br>T.L. | BELLED<br>PART<br>NO. |
|------------------------------------------------------------------------------------|-------|------|--------------|-----------------------|---------------------------|-----------------------|------------------------|-----------------------|
|                                                                                    | *1/2" | .840 | .062         | 9.81                  | 2.000                     | 8400                  | 44                     | 57015                 |
| 3/4                                                                                | 1.050 | .060 | 12.11        | 2.125                 | 6600                      | 40                    | 57030                  |                       |
| 1                                                                                  | 1.315 | .063 | 16.17        | 2.375                 | 5400                      | 32                    | 57045                  |                       |
| 1 1/4                                                                              | 1.660 | .079 | 25.59        | 2.750                 | 4000                      | 32                    | 57055                  |                       |
| 1 1/2                                                                              | 1.900 | .090 | 33.32        | 3.000                 | 3600                      | 28                    | 57070                  |                       |
| 2                                                                                  | 2.375 | .113 | 52.32        | 3.000                 | 2800                      | 24                    | 57085                  |                       |
| 2 1/2                                                                              | 2.875 | .137 | 76.53        | 3.500                 | 2240                      | 20                    | 57100                  |                       |
| 3                                                                                  | 3.500 | .167 | 113.71       | 4.000                 | 1500                      | 20                    | 57110                  |                       |
| 4                                                                                  | 4.500 | .214 | 192.22       | 5.000                 | 580                       | 28                    | 57120                  |                       |
| 6                                                                                  | 6.625 | .316 | 420.11       | 6.500                 | 400                       | 20                    | 57130                  |                       |

\*SDR 13.5 - 315 PSI

| SCH-40<br>SOLVENT WELD<br>RECLAIMED WATER PIPE<br>PVC1120<br>ASTM D1785 | SIZE  | O.D.  | MIN.<br>WALL | WEIGHT<br>PER<br>100' | SOCKET<br>DEPTH<br>INCHES | FEET<br>PER<br>PALLET | PALLETS<br>PER<br>T.L. | BELLED<br>PART<br>NO. |
|-------------------------------------------------------------------------|-------|-------|--------------|-----------------------|---------------------------|-----------------------|------------------------|-----------------------|
|                                                                         | 3/4"  | 1.050 | .113         | 21.58                 | 2.125                     | 6600                  | 40                     | 57230                 |
|                                                                         | 1     | 1.315 | .133         | 32.00                 | 2.375                     | 5400                  | 32                     | 57245                 |
|                                                                         | 1 1/4 | 1.660 | .140         | 43.40                 | 2.750                     | 4000                  | 32                     | 57255                 |
|                                                                         | 1 1/2 | 1.900 | .145         | 51.83                 | 3.000                     | 3600                  | 28                     | 57270                 |
|                                                                         | 2     | 2.375 | .154         | 69.71                 | 3.000                     | 2800                  | 24                     | 57285                 |
|                                                                         | 2 1/2 | 2.875 | .203         | 110.57                | 3.500                     | 2240                  | 20                     | 57300                 |
|                                                                         | 3     | 3.500 | .216         | 144.82                | 4.000                     | 1500                  | 20                     | 57310                 |
| 4                                                                       | 4.500 | .237  | 211.35       | 5.000                 | 580                       | 28                    | 57320                  |                       |

| SDR-21<br>GASKET JOINT<br>RECLAIMED WATER PIPE<br>200 PSI<br>PVC1120<br>ASTM D2241 | SIZE | O.D.  | MIN.<br>WALL | WEIGHT<br>PER<br>100' | SOCKET<br>DEPTH<br>INCHES | FEET<br>PER<br>PALLET | PALLETS<br>PER<br>T.L. | BELLED<br>PART<br>NO. |
|------------------------------------------------------------------------------------|------|-------|--------------|-----------------------|---------------------------|-----------------------|------------------------|-----------------------|
|                                                                                    | *3"  | 3.500 | .167         | 116.68                | 5.000                     | 1160                  | 20                     | 57180                 |
|                                                                                    | *4   | 4.500 | .214         | 193.02                | 6.000                     | 760                   | 20                     | 57187                 |
|                                                                                    | *6   | 6.625 | .316         | 420.57                | 6.750                     | 360                   | 20                     | 57195                 |

\*20 FT. LAYING LENGTH ± 1".

GASKET JOINT PIPE IS PRODUCED WITH AN INTEGRAL BELL END WITH A REINFORCED GASKET CONFORMING TO ASTM F477.

CRESLINE RECLAIMED WATER PIPE IS PURPLE IN COLOR.

**CRESLINE-WEST®**

**PVC-DS PIPE - ASTM D-2729**

WHEN ORDERING ORDER BY PART NUMBER  
ADDITIONAL 10% CHARGE IF NOT ORDERED IN PALLET QUANTITIES.

| PVC-DS<br>ASTM D-2729<br>SOLID<br>&<br>PERFORATED | SIZE  | O.D.  | MIN.<br>WALL | WEIGHT<br>PER<br>100' | FEET<br>PER<br>PALLET | PALLETS<br>PER<br>T.L. | PART<br>NO.<br>SOLID | PART<br>NO.<br>PERF. |
|---------------------------------------------------|-------|-------|--------------|-----------------------|-----------------------|------------------------|----------------------|----------------------|
|                                                   | 3     | 3.250 | .070         | 45.45                 | 1000                  | 32                     | 52805                | 52880                |
| 4                                                 | 4.215 | .075  | 63.57        | 900                   | 24                    | 52815                  | 52910                |                      |
| 4*                                                | 4.215 | .075  | 63.57        | 900                   | 24                    |                        | 52935                |                      |
| 6                                                 | 6.275 | .100  | 126.43       | 350                   | 24                    | 52155                  | 52260                |                      |

FURNISHED IN 10' LENGTHS BELLED END.

CRESLINE PVC-DS PIPE CONFORMS TO ASTM D-2729 SPECIFICATIONS.

PERFORATED WITH 2 ROWS OF 5/8" HOLES ON 5" CENTERS 120° APART. MEETS MICHIGAN STANDARD.

\*PERFORATED WITH 3 ROWS OF 5/8" HOLES ON 5" CENTERS 120° APART. MEETS INDIANA CODE.

**The Best Conditions Require the Best Partners.**  
**LEAN ON US!!!**

Scan the QR Code and let us know how we can help you.





## PJ Adapter for Push-Joint Gate Valves

### FEATURES

- Use readily available push-joint gate valves
- Connects IPS push-joint gate valves to IPS PE pipe
- No fusion of awkward fusible PE gate valves
- No bolt torquing and retorquing required for flanged or MJ gate valves

### BENEFITS

- Simplifies installation of iron gate valves to PE pipe
- Fits any IPS push-joint gate valve
- Fits push-joint gate valves for IPS pipe in common usage in waterworks and irrigation industries
- Works with typical brands made by American, AVK, Clow, Kennedy, Matco-Norca, M&H and Nibco (call for others)
- While gate valves with PE ends can be awkward to handle and fuse (with a risk of a valve not being vertical after fusing and recovery being difficult), the PJ adapter system from HARCO has no such issues
- Torquing of flange and MJ joints is eliminated
- Has fewer parts and allows for speedy installation requiring no retorquing of bolts – with this system there is no “wait time” for retorquing

### PJ Adapters

| SKU       | Description                  |
|-----------|------------------------------|
| 65-317503 | 3" DR11 x DR11 PJ adapter    |
| 65-327503 | 3" DR11 x DR13.5 PJ adapter  |
| 65-317504 | 4" DR11 x DR11 PJ adapter    |
| 65-327504 | 4" DR11 x DR13.5 PJ adapter  |
| 65-317506 | 6" DR11 x DR11 PJ adapter    |
| 65-327506 | 6" DR11 x DR13.5 PJ adapter  |
| 65-317508 | 8" DR11 x DR11 PJ adapter    |
| 65-327508 | 8" DR11 x DR13.5 PJ adapter  |
| 65-317510 | 10" DR11 x DR11 PJ adapter   |
| 65-327510 | 10" DR11 x DR13.5 PJ adapter |
| 65-317512 | 12" DR11 x DR11 PJ adapter   |
| 65-327512 | 12" DR11 x DR13.5 PJ adapter |

### PJ Adapter Accessory Kits for PE x PE Connection (1 kit needed for every 2 adapters)

| SKU        | Description                                |
|------------|--------------------------------------------|
| 65-077503  | 3" Acc. kit standard coating and hardware  |
| 65-077503S | 3" Acc. kit FBE coating, 316 SS hardware   |
| 65-077504  | 4" acc. Kit standard Coating and hardware  |
| 65-077504S | 4" Acc. kit FBE coating, 316 SS hardware   |
| 65-077506  | 6" Acc. kit standard coating and hardware  |
| 65-077506S | 6" Acc. kit FBE coating, 316 SS hardware   |
| 65-077508  | 8" Acc. kit standard coating and hardware  |
| 65-077508S | 8" Acc. kit FBE coating, 316 SS hardware   |
| 65-077510  | 10" Acc. kit standard coating and hardware |
| 65-077510S | 10" Acc. kit FBE coating, 316 SS hardware  |
| 65-077512  | 12" Acc. kit standard coating and hardware |
| 65-077512S | 12" Acc. kit FBE coating, 316 SS hardware  |

### PJ Adapter Accessory Kits for PE x PVC Connection (1 kit needed for each adapter)

| SKU        | Description                                |
|------------|--------------------------------------------|
| 65-078503  | 3" acc. kit standard coating and hardware  |
| 65-078503s | 3" acc. kit FBE coating, 316 SS hardware   |
| 65-078504  | 4" acc. kit standard coating and hardware  |
| 65-078504s | 4" acc. kit FBE coating, 316 SS hardware   |
| 65-078506  | 6" acc. kit standard coating and hardware  |
| 65-078506s | 6" acc. kit FBE coating, 316 SS hardware   |
| 65-078508  | 8" acc. kit standard coating and hardware  |
| 65-078508s | 8" acc. kit FBE coating, 316 SS hardware   |
| 65-078510  | 10" acc. kit standard coating and hardware |
| 65-078510s | 10" acc. kit FBE coating, 316 SS hardware  |
| 65-078512  | 12" acc. kit standard coating and hardware |
| 65-078512s | 12" acc. kit FBE coating, 316 SS hardware  |

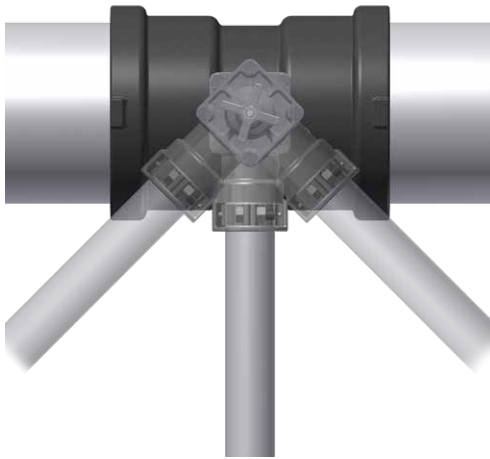

## Swivel Joint Lateral Connection

Lateral-to-main connections are now quick, easy and durable. HARCO ductile iron lateral 90°s, lateral nipples, service tees, saddles and lateral isolation valves equipped with the swivel joint make for quick and problem-free connections that are easy to seal and orient unlike conventional NPT pipe joints. Ductile iron construction makes for long-term reliability. The swivel joint lateral connection system can be used in PVC or PE systems and is covered by U.S. Patent # 4,055,865.

### No tape or paste and true 360° of lateral orientation

Simply lube the gasket and spigot with ordinary pipe lube, thread the connection home and then rotate the joint back to the desired lateral line direction. No risk or strain of overtightening a joint or risk of losing seal.

### Universal mainline branch connection

Swivel tees and swivel saddles are provided with a universal branch design serving all sizes of lateral 90°s and lateral nipples. No more ordering the wrong size branch outlet. The joint is based on the proven 2½" joint used in HARCO ductile iron fittings. The flow way is maximized, and transitions are tapered to smooth flow through the joint.

### Eliminate NPT threads and glue joints with swivel joint systems for push-on valves

Outlets of valves are restrained to the pipe with mechanical joint restraint. See information on HARCO restraints for additional options

### Different riser elevations

Different riser elevations are served with lateral 90°s and lateral nipples of various lengths. For special situations swivel extensions are available that provide height adjustments in 6" increments.

### Side Outlet Taps

Side Outlet taps are available for all lateral 90°s, lateral nipples and swivel extensions to utilize quick coupler valves.

### No extra pieces

With the swivel joint there is no need for "collar-style clamps" that must be bolted together. There are no restraint links requiring screws to attach to valves. There are no "clips" required to permit 360° of rotation or to hold the valve in place. Joint restraint for lateral isolation valves requires only one clamp bolt to actuate.

### Full Port Lateral Isolation Valves, Stainless Steel, Male Swivel X Gasket (outlet size x height from top of main to top of lateral)



| SKU       | Description                         |
|-----------|-------------------------------------|
| 8411062PQ | 2" x 6" with cross handle           |
| 8411122PQ | 2" x 12"* with cross handle         |
| 8412062PQ | 2½" x 6" with cross handle          |
| 8413062PQ | 3 x 6" with cross handle            |
| 8414062PQ | 4 x 6" with cross handle            |
| 8411062PR | 2" x 6" with square operating nut   |
| 8411122PR | 2" x 12"* with square operating nut |
| 8412062PR | 2½" x 6" with square operating nut  |
| 8413062PR | 3" x 6" with square operating nut   |
| 8414062PR | 4" x 6" with square operating nut   |

\* 2" x 12" valves are assembled from 2"x6" valves and fusion bond coated 6" extensions

### Standard Port Lateral Isolation Valves, Stainless Steel, Male Swivel X Gasket (outlet size x height from top of main to top of lateral)



| SKU      | Description               |
|----------|---------------------------|
| 8431065Q | 2" x 6" with cross handle |

### Standard Port Lateral Isolation Valves, Stainless Steel, Gasket X Gasket (outlet size x height from top of main to top of lateral)



| SKU      | Description          |
|----------|----------------------|
| 8431GG5Q | 2" with cross handle |





## Swivel Joint Lateral Connection (cont'd)

### Swivel Service Tee for PVC Pipe



| SKU     | Description  |
|---------|--------------|
| 8015405 | 2" x swivel  |
| 8025405 | 2½" x swivel |
| 8035405 | 3" x swivel  |
| 8045405 | 4" x swivel  |
| 8065405 | 6" x swivel  |
| 8085405 | 8" x swivel  |
| 8105405 | 10" x swivel |
| 8125405 | 12" x swivel |
| 8145405 | 14" x swivel |
| 8165405 | 16" x swivel |

### Swivel Saddle for PVC or PE Pipe (double strap)



| SKU    | Description  |
|--------|--------------|
| 80381H | 3" x swivel  |
| 80481H | 4" x swivel  |
| 80681H | 6" x swivel  |
| 80881H | 8" x swivel  |
| 81081H | 10" x swivel |
| 81281H | 12" x swivel |
| 81481H | 14" x swivel |
| 81681H | 16" x swivel |

### Swivel Saddle for PVC Pipe (single strap)



| SKU   | Description  |
|-------|--------------|
| 80381 | 3" x swivel  |
| 80481 | 4" x swivel  |
| 80681 | 6" x swivel  |
| 80881 | 8" x swivel  |
| 81081 | 10" x swivel |
| 81281 | 12" x swivel |

### Electro Fusion Swivel Saddle PE Pipe (SS swivel)



| SKU      | Description        |
|----------|--------------------|
| 70-5303S | 3" EF x swivel     |
| 70-5304S | 4" EF x swivel     |
| 70-5306S | 6" EF x swivel     |
| 70-5308S | 8" EF x swivel     |
| 70-5310S | 10" EF x swivel    |
| 70-5312S | 12" EF x swivel    |
| 70-5314S | 14-24" EF x swivel |

### Electro Fusion Swivel Saddle PE Pipe (SS swivel w/1" side outlet plugged)



| SKU          | Description                            |
|--------------|----------------------------------------|
| 70-5303S-SOP | 3" EF x swivel w/1" outlet/plugged     |
| 70-5304S-SOP | 4" EF x swivel w/1" outlet/plugged     |
| 70-5306S-SOP | 6" EF x swivel w/1" outlet/plugged     |
| 70-5308S-SOP | 8" EF x swivel w/1" outlet/plugged     |
| 70-5310S-SOP | 10" EF x swivel w/1" outlet/plugged    |
| 70-5312S-SOP | 12" EF x swivel w/1" outlet/plugged    |
| 70-5314S-SOP | 14-24" EF x swivel w/1" outlet/plugged |



## Swivel Joint Lateral Connection (cont'd)

### Swivel Extension (male swivel x female swivel)



| SKU   | Description   |
|-------|---------------|
| 87106 | 6" extension  |
| 87112 | 12" extension |

### Swivel Extension with 1" Side Outlet (male swivel x female swivel)



| SKU       | Description                                      |
|-----------|--------------------------------------------------|
| 87106S0F  | 4" ext, 1" side outlet, FBC ductile iron         |
| 87106S0PF | 4" ext, 1" side outlet plugged, FBC ductile iron |
| 87106S0S  | 4" ext, 1" side outlet, stainless steel          |
| 87106S0PS | 4" ext, 1" side outlet plugged, stainless steel  |

### Female Swivel Adapter



| SKU     | Description             |
|---------|-------------------------|
| 873-008 | 2" MNPT x female swivel |

### Female NPT Swivel Adapter



| SKU        | Description            |
|------------|------------------------|
| 875-025-06 | 1½" FNPT x male swivel |
| 875-025-08 | 2" FNPT x male swivel  |
| 875-025-10 | 2½" FNPT x male swivel |
| 875-025-12 | 3" FNPT x male swivel  |

### Spigot X Male NPT Adapter

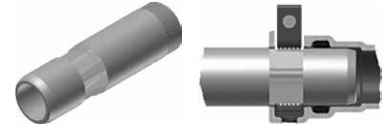

| SKU     | Description                  |
|---------|------------------------------|
| 8740606 | 1½" spigot x NPT x 6" length |
| 8740408 | 2" spigot x NPT x 4" length  |
| 8740608 | 2" spigot x NPT x 6" length  |
| 8740808 | 2" spigot x NPT x 8" length  |
| 8741008 | 2" spigot x NPT x 10" length |
| 8741208 | 2" spigot x NPT x 12" length |
| 8740610 | 2½" spigot x NPT x 6" length |
| 8740612 | 3" spigot x NPT x 6" length  |

### Compact Spigot X Male NPT Adapter

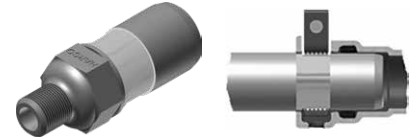

| SKU       | Description         |
|-----------|---------------------|
| 874030804 | 2" spigot x 1" NPT  |
| 874030805 | 2" spigot x 1¼" NPT |
| 874030806 | 2" spigot x 1½" NPT |
| 874030808 | 2" spigot x 2" NPT  |
| 874030810 | 2" spigot x 2½" NPT |

## L2-SERIES

**Stainless-steel quick-coupling valves**

### FEATURES

- 100% stainless steel
- L2 “latch and lock” safety technology
- Adjustable water flow technology
- 1” FPT or ACME inlet



| SKU              | Description              |
|------------------|--------------------------|
| L2QCV-FPT-P      | 1” FPT inlet purple cap  |
| L2QCV-KEY        | Quick-coupling valve key |
| L2QCV-SWIVEL-010 | 1” hose swivel           |

## LV-SERIES

**Stainless-steel angle valves**

### FEATURES

- 100% stainless steel
- Restrained bell outlet
- Offered X-top or SON
- 2”- 4” sizes



| SKU     | Description |
|---------|-------------|
| LV-212S | 2x12 valve  |
| LV-210S | 2x12 valve  |
| LV-202S | 2x12 valve  |
| LV-300S | 3x12 valve  |

## LGT-SERIES

**Stainless-steel gate valves**

### FEATURES

- 100% stainless steel
- 100% lead free
- Offered X-top or wheel handle
- 200psi CWP rated
- 1”- 4” sizes



| SKU           | Description             |
|---------------|-------------------------|
| LGT11SS304X   | 1” gate valve X handle  |
| LGT1515SS304X | 1½” gate valve X handle |
| LGT22SS304X   | 2” gate valve X handle  |

## RSST-SERIES

**Stainless-steel saddles**

### FEATURES

- 100% stainless steel
- 1½” FPT or ACME outlets
- Easy to install two-bolt design
- Compatible with PVC and HDPE pipe
- 1½”- 4” sizes



| SKU       | Description          |
|-----------|----------------------|
| RSST-215A | 2” x 1½” ACME outlet |
| RSST-315A | 3” x 1½” ACME outlet |
| RSST-415A | 4” x 1½” ACME outlet |

## LMV-MM

**Ductile iron resilient wedge gate valves**

### FEATURES

- MJ x MJ design
- Durable FBE coating
- Top shroud accepts pipe sleeve
- 3”- 24” sizes



| SKU      | Description |
|----------|-------------|
| LMV-44MM | 4” MJ       |
| LMV-66MM | 6” MJ       |
| LMV-88MM | 8” MJ       |

## LMV-BBHDSSGR

**Ductile iron resilient wedge gate valves**

### FEATURES

- Bell x Bell design for HDPE pipe
- Built in joint restraint grip ring
- Durable FBE coating
- Top shroud accepts pipe sleeve
- 2”- 12” DR11 or DR13.5 sizes
- Includes two SS pipe stiffeners



| SKU            | Description    |
|----------------|----------------|
| LMV-44BBHDSSGR | 4” bell x bell |
| LMV-66BBHDSSGR | 6” bell x bell |
| LMV-88BBHDSSGR | 8” bell x bell |



## UltraMax™ Blue Hose

All-weather performance means great flexibility even in mild temperatures and up to 45% lighter than comparable commercial-quality hoses.

### FEATURES

- 1200 psi – best burst pressure
- Soft and flexible, won't scuff greens
- Least likely to kink
- Best combo of lightweight and durability



| SKU      | Description                   |
|----------|-------------------------------|
| H75-S10  | ¾" x 10' Shorty Pro           |
| H75-S20  | ¾" x 20' Shorty Pro           |
| H75-050B | ¾" x 50' UltraMax™ blue hose  |
| H75-075B | ¾" x 75' UltraMax™ blue hose  |
| H75-100B | ¾" x 100' UltraMax™ blue hose |
| H75-125B | ¾" x 125' UltraMax™ blue hose |
| H10-S10  | 1" x 10' Shorty Pro           |
| H10-S20  | 1" x 20' Shorty Pro           |
| H10-050B | 1" x 50' UltraMax™ blue hose  |
| H10-075B | 1" x 75' UltraMax™ blue hose  |
| H10-100B | 1" x 100' UltraMax™ blue hose |
| H10-125B | 1" x 125' UltraMax™ blue hose |

## UltraMax™ Red Hose

Ultimate choice rubber hose for a long life under heavy use

### FEATURES

- 800 psi
- Heavy-duty and durable
- Kink/tangle resistant
- Best longevity and ability to drag



| SKU      | Description                  |
|----------|------------------------------|
| H75-025R | ¾" x 25' UltraMax™ red hose  |
| H75-050R | ¾" x 50' UltraMax™ red hose  |
| H75-075R | ¾" x 75' UltraMax™ red hose  |
| H75-100R | ¾" x 100' UltraMax™ red hose |
| H75-125R | ¾" x 125' UltraMax™ red hose |
| H10-025R | 1" x 25' UltraMax™ red hose  |
| H10-050R | 1" x 50' UltraMax™ red hose  |
| H10-075R | 1" x 75' UltraMax™ red hose  |
| H10-100R | 1" x 100' UltraMax™ red hose |
| H10-125R | 1" x 125' UltraMax™ red hose |

## UltraMax™ Green Hose

A lightweight hose suitable for a wide range of multipurpose commercial applications.

### FEATURES

- 800 psi
- Longtime favorite
- Smooth texture – won't scuff greens
- Lightweight



| SKU      | Description                    |
|----------|--------------------------------|
| H75-050G | ¾" x 50' UltraMax™ green hose  |
| H75-075G | ¾" x 75' UltraMax™ green hose  |
| H75-100G | ¾" x 100' UltraMax™ green hose |
| H75-125G | ¾" x 125' UltraMax™ green hose |
| H10-050G | 1" x 50' UltraMax™ green hose  |
| H10-075G | 1" x 75' UltraMax™ green hose  |
| H10-100G | 1" x 100' UltraMax™ green hose |
| H10-125G | 1" x 125' UltraMax™ green hose |

## UltraMax™ Clear Hose

Lightest weight and economical hose ideal for light to medium commercial duty, including golf greens.

### FEATURES

- 600 psi
- Lightweight and user friendly
- Durable outer wall
- Economical



| SKU      | Description                    |
|----------|--------------------------------|
| H75-050G | ¾" x 50' UltraMax™ clear hose  |
| H75-075G | ¾" x 75' UltraMax™ clear hose  |
| H75-100G | ¾" x 100' UltraMax™ clear hose |
| H75-125G | ¾" x 125' UltraMax™ clear hose |
| H10-050G | 1" x 50' UltraMax™ clear hose  |
| H10-075G | 1" x 75' UltraMax™ clear hose  |
| H10-100G | 1" x 100' UltraMax™ clear hose |
| H10-125G | 1" x 125' UltraMax™ clear hose |

## Featherweight UltraMax™ Hose



Featherweight UltraMax™ hose is the lightest, highest quality hose on the market with nearly no kinking.

### FEATURES

- New higher flow rate provides equal flow as PVC or rubber hoses
- Ultra-Smooth outer polyester fabric slides across turf without scuffing
- Extremely lightweight - 1" x 100' weighs 15 lb
- Easy to maneuver, roll and kink resistant
- Rubber guards on both ends prevent kinking
- 300 psi working pressure / 1,200 psi burst pressure

| SKU       | Description                            |
|-----------|----------------------------------------|
| H75-S20FW | ¾" Shorty Pro x 20' featherweight hose |
| H75-050FW | ¾" x 50' featherweight hose            |
| H75-075FW | ¾" x 75' featherweight hose            |
| H75-100FW | ¾" x 100' featherweight hose           |
| H75-125FW | ¾" x 125' featherweight hose           |
| H10-S20FW | 1" Shorty Pro x 20' featherweight hose |
| H10-050FW | 1" x 50' featherweight hose            |
| H10-075FW | 1" x 75' featherweight hose            |
| H10-100FW | 1" x 100' featherweight hose           |
| H10-125FW | 1" x 125' featherweight hose           |
| H10-150FW | 1" x 150' featherweight hose           |

## Twist-Ease Hose Kink Eliminator



Add this fitting to any hose and you'll never fight a kinked hose again.

### FEATURES

- Available for 1" or ¾" hoses
- Fits between male hose end and nozzle
- Allows hose to continuously untwist itself

| SKU     | Description                        |
|---------|------------------------------------|
| HSF-75  | ¾" Twist-Ease hose kink eliminator |
| HSF-100 | 1" Twist-Ease hose kink eliminator |

## Hose Caddie™ Reel



Our new and improved Hose Caddie™ holds more hose, has no flow rate loss and is the best-quality hose reel in the irrigation market.

### FEATURES

- Now carries over 125' of 1" or 150' of ¾" hose
- Quick coupler key holder mounted to frame
- New Powerflow™ internal parts provide highest possible flow rate
- Optional hose guide mounts to reel for easy winding
- Includes a 10' UltraMax™ blue leader hose
- Base has four pre-drilled holes for easy mounting

| SKU    | Description         |
|--------|---------------------|
| HC-075 | ¾" hose caddie reel |
| HC-100 | 1" hose caddie reel |
| HC-HG  | Optional hose guide |

## Course Caddie™ Hose Trailer



Stop lifting heavy hoses in and out of your utility vehicle. Our Course Caddie™ trailer is perfectly designed in strength and function for professional turf managers. We thought out every detail from the high-flow Hose Caddie™ reel mounted securely to the trailer to the full size golf cart tires and hubs for a smooth and quiet ride.

### FEATURES

- Strongest, most durable hose trailer on the market
- Holds over 125' of 1" or 150' of ¾" hose
- New Powerflow™ reel provides highest possible flow rate
- 10' UltraMax™ blue leader hose included
- Full-size golf cart tires and hubs
- Optional high-quality tool box fits most tools and accessories and includes lockable top

| SKU          | Description                                                                          |
|--------------|--------------------------------------------------------------------------------------|
| HC-TRL-075   | ¾" hose reel mounted to trailer w/ ¾" x 10' leader hose                              |
| HC-TRL-100   | 1" hose reel mounted to trailer w/ 1" x 10' leader hose                              |
| HC-TRL-TOOL  | Tool box attachment, includes mounting hardware                                      |
| HC-TRL-075-K | Turnkey ¾" kit - includes Course Caddie™, tool box and ¾" x 125' UltraMax™ blue hose |
| HC-TRL-100-K | Turnkey 1" kit - includes Course Caddie™, tool box and 1" x 100' UltraMax™ blue hose |



## Magnum™ Nozzle

This is a commercial- and fire hose-quality nozzle that's inexpensive and feels great in your hands.



### FEATURES

- Solid metal internal – no plastic parts to break or wear out
- Multipattern sprays – effortless control with hydraulic-assist on/off
- Ratchet mechanism prevents over-tightening damage

| SKU   | Description    |
|-------|----------------|
| NG450 | Magnum™ nozzle |

## Magnum™ UltraMax™ Full-Throttle Nozzle

This is the highest quality professional nozzle available



### FEATURES

- Single variable flow delivers steady, maximum volume fog, jet stream and fan patterns
- Available with ¾" or 1" inlet
- Machined aircraft aluminum, stainless-steel components and TPR rubber over-molding

| SKU           | Description                                               |
|---------------|-----------------------------------------------------------|
| NG500-SFL-75  | ¾" low-flow Magnum™ UltraMax™ full throttle nozzle        |
| NG500-SFL-10  | 1" low-flow Magnum™ UltraMax™ full throttle nozzle        |
| NG500-SFH-75  | ¾" high-flow Magnum™ UltraMax™ full throttle nozzle       |
| NG500-SFH-10  | 1" high-flow Magnum™ UltraMax™ full throttle nozzle       |
| NG500-SFSH-10 | 1" super high-flow Magnum™ UltraMax™ full throttle nozzle |

## Magnum™ UltraMax™ Turbo Shift Nozzle

This is the highest quality professional nozzle available



### FEATURES

- Dual variable flow – delivers light fog and low-volume jet stream patterns before shifting to high-volume jet stream and fan patterns
- Available with ¾" or 1" inlet
- Machined aircraft aluminum, stainless-steel components and TPR rubber over-molding

| SKU           | Description                                            |
|---------------|--------------------------------------------------------|
| NG550-DFL-75  | ¾" low-flow Magnum™ UltraMax turbo shift nozzle        |
| NG550-DFL-10  | 1" low-flow Magnum™ UltraMax turbo shift nozzle        |
| NG550-DFH-75  | ¾" high-flow Magnum™ UltraMax turbo shift nozzle       |
| NG550-DFH-10  | 1" high-flow Magnum™ UltraMax turbo shift nozzle       |
| NG550-DFSH-10 | 1" super high-flow Magnum™ UltraMax turbo shift nozzle |

## Magnum™ UltraMax™ Full-Throttle Nozzle

This nozzle offers all the performance of our pro series nozzles at half the price.



### FEATURES

- Machined aircraft aluminum, high-strength composite internals with TPR rubber over-molding
- Single variable flow delivers steady, maximum volume fog, jet stream and fan patterns
- Available with ¾" or 1" inlet

| SKU          | Description                                         |
|--------------|-----------------------------------------------------|
| NG600-SFH-75 | ¾" high-flow Magnum™ UltraMax™ full-throttle nozzle |
| NG600-SFH-10 | 1" high-flow Magnum™ UltraMax™ full-throttle nozzle |

## Magnum™ UltraMax™ Turbo Shift Nozzle

This nozzle offers all the performance of our pro series nozzles at half the price.



### FEATURES

- Machined aircraft aluminum, high-strength composite internals with TPR rubber over-molding
- Dual variable flow delivers light fog and low-volume jet stream patterns before shifting to high-volume jet stream and fan patterns
- Available with ¾" or 1" inlet

| SKU          | Description                                       |
|--------------|---------------------------------------------------|
| NG650-DFH-75 | ¾" high-flow Magnum™ UltraMax™ turbo shift nozzle |
| NG650-DFH-10 | 1" high-flow Magnum™ UltraMax™ turbo shift nozzle |

## Precision™ Nozzles

### FEATURES

- Solid brass, machined construction
- ¾" FHT inlet can attach directly to a hose or to a high-flow control valve
- Color-coded nozzles represent different applications and flow rates
- Unique fish-mouth design ensures uniform and even distribution pattern



| SKU      | Description                                            |
|----------|--------------------------------------------------------|
| HN1500   | Precision™ Rainbow™ nozzle, yellow, 15 GPM             |
| HN1500CV | Includes control valve and 1" adapters, yellow, 15 GPM |
| HN2300   | Precision™ Rainmaker™ nozzle, green, 23 GPM            |
| HN2300CV | Includes control valve and 1" adapters, green, 23 GPM  |
| HN4800   | Precision™ Cloudburst™ nozzle, blue, 35 GPM            |
| HN4800CV | Includes control valve and 1" adapters, blue, 35 GPM   |
| HN5000   | Precision™ Cyclone™ nozzle, red, 50 GPM                |
| HN5000CV | Includes control valve and 1" adapters, red, 50 GPM    |

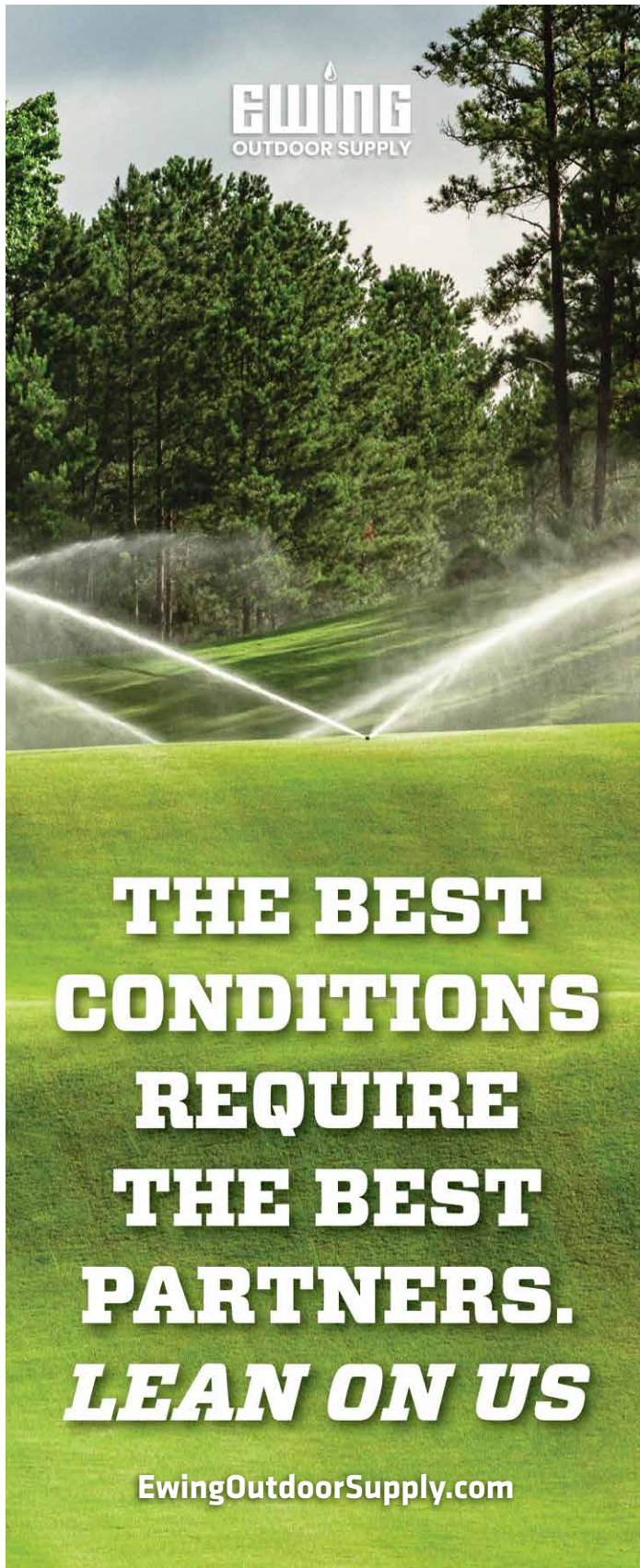

**EWING**  
OUTDOOR SUPPLY

**THE BEST  
CONDITIONS  
REQUIRE  
THE BEST  
PARTNERS.  
LEAN ON US**

EwingOutdoorSupply.com

## Big Gulp™ Pro Pump

### FEATURES

- The only pump that completely disassembles for easy cleaning and longer life
- 36" pump with 72" flexible outlet hose
- Thick, heavy-duty polycarbonate cylinder body will not break
- Pump shaft – aircraft aluminum – low flexibility and virtually unbreakable
- Exclusive MudGuard comes standard – minimizes clogging, makes pumping easier

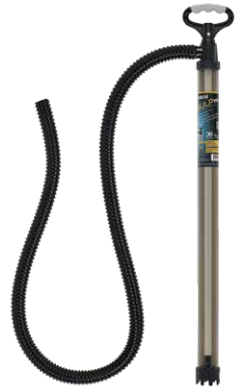

| SKU | Description |
|-----|-------------|
|-----|-------------|

|            |                    |
|------------|--------------------|
| A-G3672-CK | Big Gulp™ pro pump |
|------------|--------------------|

## Gulp™ Pro Pump

### FEATURES

- The only pump that completely disassembles for easy cleaning and longer life
- 22" pump with 36" flexible outlet hose
- Thick, heavy-duty polycarbonate cylinder body will not break
- Pump shaft – aircraft aluminum – low flexibility and virtually unbreakable
- Exclusive MudGuard comes standard – minimizes clogging, makes pumping easier



| SKU | Description |
|-----|-------------|
|-----|-------------|

|           |                |
|-----------|----------------|
| A-G1236-C | Gulp™ pro pump |
|-----------|----------------|

## Gulp™ Pro Syringe

### FEATURES

- 24" length with 17" hose
- 17" tube for getting into the smallest openings



| SKU | Description |
|-----|-------------|
|-----|-------------|

|          |                   |
|----------|-------------------|
| A-G12S-C | Gulp™ pro syringe |
|----------|-------------------|



## Precision™ CoolPro™ Nozzle with Control Valve

The best-option nozzle for syringing greens without overwatering.

### FEATURES

- Ergonomic handle/valve provides easy grip and variable on/off control
- Durable solid metal design – zinc, aircraft aluminum and stainless steel
- Patented Precision™ nozzle fogs at 70 psi to deliver a 25' pattern with only 4-6 gpm



| SKU    | Description                                   |
|--------|-----------------------------------------------|
| HNC075 | Precision™ CoolPro™ nozzle with control valve |

## Brass High-Flow Control Shut-Off Valve

This control shut-off valve has the highest flow rate compared to other brands.

### FEATURES

- ¾" or 1" inlet brass
- Heavy-duty construction – made to last
- Highest flow rate compared to other brands



| SKU    | Description                               |
|--------|-------------------------------------------|
| CV075H | ¾" brass high-flow control shut-off valve |
| CV10H  | 1" brass high-flow control shut-off valve |

## The Extender™

### FEATURES

- Lengthens any quick coupler key 4" to reach those low quick coupler valves
- Built-in handle makes it easy to turn and work with
- Works with all brands of quick coupler keys
- No need to dig and raise low valves – stop digging, start extending



| SKU      | Description   |
|----------|---------------|
| QK-075EX | ¾" Extender™  |
| QK-100EX | 1" Extender™  |
| QK-150EX | 1½" Extender™ |

## DrainBlaster™

### FEATURES

- Great for cleaning under sidewalks or cart paths
- Ideal for 4" -6" drains and catch basins
- Wire attachment connector for mapping drain location under greens, bunkers and other locations using wire locator
- ¾" or 1" FHT inlets (not NPT or pipe threads)

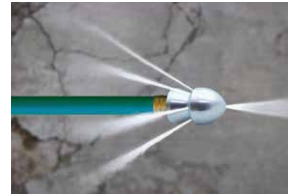

| SKU   | Description          |
|-------|----------------------|
| DN-75 | ¾" FHT DrainBlaster™ |
| DN-10 | 1" FHT DrainBlaster™ |

## PelletPro™

Applicator gun for solid wetting agents tablets

### FEATURES

- 35+ gpm to get the job done quicker
- Heavy-duty construction – brass fittings, aircraft aluminum, stainless steel, precision engineered glass
- Pellet rotation (1 RPS) evenly dissolves/applies tablets



| SKU       | Description               |
|-----------|---------------------------|
| A-PPWA50K | PelletPro™ applicator gun |
| A-PPQ-100 | 1" inline applicator      |
| A-PPQ-075 | ¾" inline applicator      |

## Tournament-Ready™ Soil Surfactant

Proven Tournament-Ready™ formula in solid pellet or liquid form

### FEATURES

- Our best performing wetting agent available in pellet form or in liquid form for use in whatever convenient method you need
- Pellets are great for treating small turf areas while hand watering using the Underhill PelletPro™ applicator
- Liquids available from 2.5 gal x 2 cases up to 265 gal totes



| SKU       | Description                                                  |
|-----------|--------------------------------------------------------------|
| UHTRPEL   | Tournament-Ready™ pellets (case of 24 pellets)               |
| UHTUR02   | Tournament-Ready soil surfactant (2.5 gal x 2 case)          |
| UHTRPLPEL | Tournament-Ready Plus w/Actosol pellets (case of 16 pellets) |



## AuditMaster™

Accurately measure sprinkler application rates with Underhill AuditMaster to help maximize water savings.

### FEATURES

- AuditMaster Combo LT kit includes 36 large CatchCan Ultra cups, 100' cloth measuring tape, sprayhead tester, pitot tube w/pressure gauge, 3/4" hose bib adapter w/pressure gauge, stop watch, anemometer and 50 (qty) white marking flags



| SKU        | Description                                  |
|------------|----------------------------------------------|
| AUD-LT     | AuditMaster™                                 |
| A-PHG-160K | PressureChecker™, 30" flex hose, pitot tube  |
| A-HCCPK    | PressureChecker™ and pitot tube              |
| A-SV-160K  | PressureChecker™ with Schrader valve adapter |
| A-HBG-160K | PressureChecker™ with 3/4" POC hose bib tap  |

## HoseTap™

Convert any Toro or Rain Bird golf valve-in-head sprinkler to a quick coupler by removing the internal drive subassembly and installing the appropriately sized hose tap.



### FEATURES

- Machined, high-quality aluminum body made for day-to-day use
- Replacement O-rings can be ordered separately
- Available with or without hose swivel

| SKU      | Description                             |
|----------|-----------------------------------------|
| HN-T100  | HoseTap™ for Toro 1" inlet heads        |
| HN-T100S | Includes hose swivel and 1" adapters    |
| HN-T150  | HoseTap™ for Toro 1½" inlet heads       |
| HN-T150S | Includes hose swivel and 1" adapters    |
| HN-R125  | HoseTap™ for Rain Bird Eagle 700 Series |
| HN-R125S | Includes hose swivel and 1" adapters    |
| HN-R150  | HoseTap™ for Rain Bird Eagle 900 Series |
| HN-R150S | Includes hose swivel and 1" adapters    |

## EasyReach Key™

Extra-long and extra heavy-duty metal key is designed for easy on/off operation.

### FEATURES

- For use with Toro, RainBird, and John Deere/Signature electric valve-inhead golf sprinklers
- Made of high-grade metal, EasyReach™ offers years of effortless on/off operation



| SKU   | Description                  |
|-------|------------------------------|
| A-ERR | EasyReach™ key for Rain Bird |
| A-ERT | EasyReach™ key for Tor       |

## Double-Header Selector Valve Key



### FEATURES

- Works on both Toro and Rain Bird heads
- Convenient key chain can stay on your key ring or go on all utility vehicles for quick access – always have a key available
- Clean-out tool makes it easy to access valve or makes a great snap ring removal tool in a pinch
- Sold in pack of nine keys with key rings

| SKU  | Description                                             |
|------|---------------------------------------------------------|
| A-DH | Double-header selector valve key (package of nine keys) |

## RollerPro™

The 22" wide stainless-steel roller of RollerPro™ provides a stable field position for supplemental watering. Designed for years of hard use, it is ideal for watering dry spots and newly seeded areas.



### FEATURES

- 22" wide stainless-steel roller is weighted to prevent movement during use
- ¾" inlet and outlet adapters included
- Standard 1" FHT inlet x 1" female NPT outlet

| SKU     | Description |
|---------|-------------|
| A-RP221 | RollerPro™  |

## TurboTrim™

### FEATURES

- Comfortable rubber handle grips
- Pro ratchet drive with left and right direction option
- Super heavy-duty steel construction and powder-coated finish



| SKU      | Description                           |
|----------|---------------------------------------|
| TTRT-100 | TurboTrim Tool, without cutting blade |
| TTRC-007 | TurboTrim 7" cutting blade            |
| TTRC-008 | TurboTrim 8" cutting blade            |
| TTRC-011 | TurboTrim 11" cutting blade           |

## PowerTrim™

### FEATURES

- Heavy-duty easy-to-install cutting blade
- Provides an effortlessly clean steady cut
- Fast quality trim, cost-efficient blade design



| SKU     | Description                 |
|---------|-----------------------------|
| PTC-007 | PowerTrim 7" cutting blade  |
| PTC-008 | PowerTrim 8" cutting blade  |
| PTC-011 | PowerTrim 11" cutting blade |

Product availability varies by location. Call your local branch for more information.

**Westlake**  
Pipe & Fittings

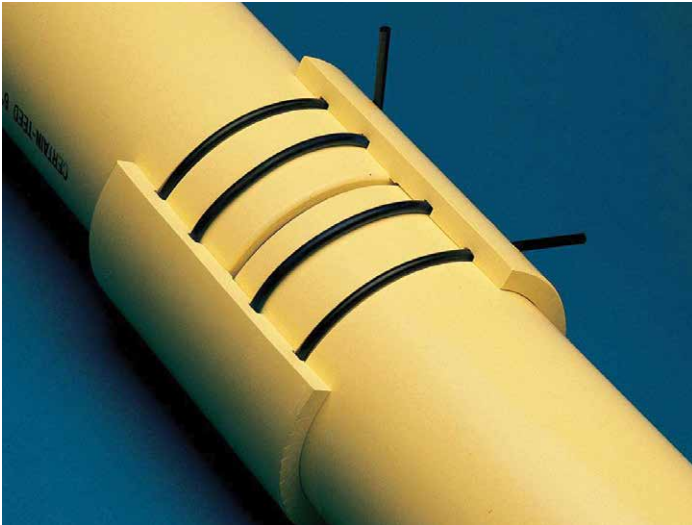

## Certa-Lok Yelomine Pipe and Fittings

Certa-Lok Yelomine PVC pressure pipe is manufactured to meet the demands of today's municipal needs for water and wastewater applications. Certa-Lok pipe utilizes precision-machined grooves on the pipe and in both sides of the coupling which, when aligned, allow a spline to be inserted, resulting in a fully circumferential restrained joint. Flexible elastomeric gaskets in the coupling provide a hydraulic seal.

**Trenchless and restrained joint open-cut applications:** This unique restrained joint pipe system is designed for trenchless applications with robust tensile strength for pulling multiple segments underground. This product reduces the jobsite footprint and minimizes community disruption with a reduced need for larger staging areas and traffic control.

**Yelomine formulation enhancement for aboveground and temporary bypass applications:** Yelomine products are manufactured from a specially formulated PVC compound that contains impact modifiers and UV inhibitors. This special formulation provides up to six times the impact strength of normal PVC pipe over an extended period of time, allowing for Yelomine products to be used aboveground and in high-impact situations like temporary bypass. Joints assembled with the non-permanent gasket option can be disassembled and reused for future jobs or system changes.

### FEATURES

- I.P.S.
- PVC
- High-impact strength
- High UV resistance
- Nylon spline restrained gasketed joints (metallic mechanical joint restraints not required)

### INSTALLATION METHODS

- Aboveground
- Temporary bypass
- Static pipe-bursting
- Horizontal directional drilling
- Open-cut

| SKU                             | Description                                             |
|---------------------------------|---------------------------------------------------------|
| D2241/RJ                        | Certa-Lok Yelomine pipe — available in 2"-16" diameters |
| Contact your Ewing rep to order |                                                         |



## Swing Joints

### FEATURES

- Proven ACME thread with o-ring seal reliability for 30+ years
- New: 1" swing joints with 1/2" and 3/4" outlets for sprays
- 315 psi working pressure rating
- 1"-3" diameters
- Leak-free head height adjustment
- 7,000+ possible configurations

| Description                                                                                                     |
|-----------------------------------------------------------------------------------------------------------------|
| See: <a href="http://lascofittings.com/swing-joint-configurator">lascofittings.com/swing-joint-configurator</a> |
| Contact your Ewing rep to order                                                                                 |

## Saddles



### FEATURES

- Designed for HDPE piping systems (iron pipe size O.D.)
- Stays fixed in position on HDPE pipe
- Female ACME thread outlet for direct connection to swing joints
- 235 psi working pressure rating
- 304 stainless-steel lubricated hardware
- Hardware is retained — won't fall into trench

### Saddle with socket top-out

| SKU     | Nominal Size (in)         | Carton Qty |
|---------|---------------------------|------------|
| 361-211 | 1 1/2" saddle x 1" socket | 5          |

Pressure rated at 235 psi per ASTM F1970

### Tap't™ saddles with FIPT top-out

| SKU     | Nominal Size (in)         | Carton Qty |
|---------|---------------------------|------------|
| 362-209 | 1 1/2" saddle x 1/2" FIPT | 2          |
| 362-210 | 1 1/2" saddle x 3/4" FIPT | 5          |
| 362-211 | 1 1/2" saddle x 1" FIPT   | 5          |

For use with swivel joints. Pressure rated at 235 psi per ASTM F1970

### Tap't™ saddles with ACME top-out

| SKU     | Nominal Size (in)        | Carton Qty |
|---------|--------------------------|------------|
| 364-251 | 2" saddle x 1 1/2" FACME | 5          |
| 364-337 | 3" saddle x 1 1/2" FACME | 5          |
| 364-419 | 4" saddle x 1 1/2" FACME | 5          |

Pressure rated at 235 psi per ASTM F1970

## Bunker Liners, Drainage and Erosion Control





## Bunker Liners

Capillary Flow is recognized as the world’s leading and most durable bunker liner. It allows water to flow through the base of the bunker while retaining sand on the faces and preventing washouts, keeping bunkers in perfect shape in any weather conditions.

### FEATURES

- Industry-leading 15-year performance guarantee
- Maintenance savings lead to high ROI. Payback on project is under 2.5 years.
- Installation can be completed in-house or by a contractor
- Homogenous mix gives you strength and longevity of liner
- Capillary wash box allows you to wash contaminants out of your sand without removing it

**Contact your local Ewing representative for further information and pricing.**



## Wash Box

For the first time ever, bunker sand can now be washed clean and into a perfect moisture-holding state – without the sand having to be removed from the bunker.

### FEATURES

- Wash your bunker sand without removing it
- The only liner that can withstand high-pressure irrigation water beam
- A “chimney” removes water from surface with dirt only
- Creates a drier bunker sand
- Conditions your sand back to new again

This not only cleans the sand but also allows the sand to dry out more in the base of the bunker where fine particles accumulate over time. This is an excellent way to condition bunker sand and improve performance and playability without having to replace or add any new sand.

| SKU      | Description |
|----------|-------------|
| 24041730 | Wash box    |

## ADS Single Wall Pipe

ADS single wall pipe delivers superior value, while providing physical strength and structural design that can't be matched by metal or concrete.

### APPLICATIONS

- Culverts
- Drains
- Sports fields
- Golf courses
- Parking lots
- Walkway drains
- Downspouts/roof drainage

### FEATURES

- Available in varying stick and coil lengths based on diameter – longer lengths result in fewer joints
- Meets soil tight joint performance
- Pipe can be easily field cut to desired length
- Lightweight pipe requires less labor and equipment for faster installation and reduced costs



### Single Wall Pipe Internal Couplers

| SKU    | Diameter | Package Quantity |
|--------|----------|------------------|
| 0315AA | 3"       | 50               |
| 0417AA | 4"       | 16               |
| 0515AA | 5"       | 12               |
| 0615AA | 6"       | 9                |

### Single Wall Pipe External Snap Couplers

| SKU    | Diameter | Package Quantity |
|--------|----------|------------------|
| 0312AA | 3"       | 24               |
| 0412AA | 4"       | 24               |
| 0512AA | 5"       | 24               |
| 0612AA | 6"       | 8                |

### Single Wall Pipe Snap End Caps

| SKU    | Diameter | Package Quantity |
|--------|----------|------------------|
| 0332AA | 3"       | 30               |
| 0432AA | 4"       | 40               |

### Single Wall Pipe Split End Caps

| SKU    | Diameter | Package Quantity |
|--------|----------|------------------|
| 0531AA | 5"       | 24               |
| 0631AA | 6"       | 12               |

### Single Wall Pipe Clay Adapters

| SKU       | Diameter | Package Quantity |
|-----------|----------|------------------|
| 0362AA    | 3"       | 24               |
| 0462AA    | 4"       | 24               |
| 0562AA    | 5"       | 24               |
| 0662AAHAN | 6"       | 11               |

### Single Wall Pipe Downspout Adapters

| SKU    | Diameter           | Package Quantity |
|--------|--------------------|------------------|
| 0364AA | 3" x 3.25" x 2.5"  | 24               |
| 0464AA | 4" x 3.25" x 2.5"  | 24               |
| 0465AA | 4" x 4.25" x 3"    | 20               |
| 0466AA | 4" x 2.56" x 2.56" | 24               |
| 0664AA | 6" x 4" x 6"       | 1                |
| 0664AC | 6" x 4" x 6"       | 1                |

### Single Wall Pipe

| SKU        | Wall Type          | Diameter | Length |
|------------|--------------------|----------|--------|
| 03510010   | Solid              | 3"       | 10'    |
| 03510100   | Solid              | 3"       | 100'   |
| 03010010   | Perforated         | 3"       | 10'    |
| 03010100   | Perforated         | 3"       | 100'   |
| 03730100BS | Perforated w/wrap  | 3"       | 100'   |
| 04510010   | Solid              | 4"       | 10'    |
| 04510100   | Solid              | 4"       | 100'   |
| 04010010   | Perforated         | 4"       | 10'    |
| 04010100   | Perforated         | 4"       | 100'   |
| 04730100BS | Perforated w/ wrap | 4"       | 100'   |
| 06510010   | Solid              | 6"       | 10'    |
| 06510020   | Solid              | 6"       | 20'    |
| 06510100   | Solid              | 6"       | 100'   |
| 06010010   | Perforated         | 6"       | 10'    |
| 06010020   | Perforated         | 6"       | 20'    |
| 06010100   | Perforated         | 6"       | 100'   |
| 06730100BS | Perforated w/wrap  | 6"       | 100'   |
| 08510020   | Solid              | 8"       | 20'    |
| 08010020   | Perforated         | 8"       | 20'    |
| 08730020   | Perforated w/wrap  | 8"       | 20'    |
| 10510020   | Solid              | 10"      | 20'    |
| 10010020   | Perforated         | 10"      | 20'    |
| 10730020   | Perforated w/wrap  | 10"      | 20'    |
| 12510020   | Solid              | 12"      | 20'    |
| 12010020   | Perforated         | 12"      | 20'    |
| 15510020   | Solid              | 15"      | 20'    |
| 15010020   | Perforated         | 15"      | 20'    |
| 18510020   | Solid              | 18"      | 20'    |
| 18010020   | Perforated         | 18"      | 20'    |
| 24510020   | Solid              | 24"      | 20'    |
| 24010020   | Perforated         | 24"      | 20'    |



## N-12 Dual Wall Pipe

ADS offers N-12 dual wall 4"-12" (100-300 mm) corrugated smooth interior pipe made from high-density polyethylene (HDPE). HDPE provides better strength than PVC to survive the impact of rocks in the backfill process. HDPE is also abrasion and corrosion resistant and is available in plain end, soil tight or watertight.

### APPLICATIONS

- Roof drains
- Foundation lines
- Culverts
- Collector pipe
- Roadway edge drains
- Construction site dewatering

### FEATURES

- Inline bell design with exceptional joint strength
- Installation cost savings
- Variety of diameters and lengths fit any project
- Joint only requires lube for fitting, does not require grout, sealing bands or additional gasket materials



Plain-end pipe



Watertight pipe

### N-12 Dual Wall Pipe (per AASHTO)

| Plain End | Soil Tight | Watertight | Diameter | Length | Wall Type         |
|-----------|------------|------------|----------|--------|-------------------|
| 04150020  |            | 04650020IB | 4"       | 20'    | Solid             |
| 04110020  | 04110020IB |            | 4"       | 20'    | Perforated        |
| 04230020  | 04230020IB |            | 4"       | 20'    | Perforated w/sock |
| 06150020  |            | 06650020IB | 6"       | 20'    | Solid             |
| 06110020  | 06110020IB |            | 6"       | 20'    | Perforated        |
| 06230020  | 06230020IB |            | 6"       | 20'    | Perforated w/sock |
| 08150020  |            | 08650020IB | 8"       | 20'    | Solid             |
| 08110020  | 08110020IB |            | 8"       | 20'    | Perforated        |
| 08230020  | 08230020IB |            | 8"       | 20'    | Perforated w/sock |
| 10150020  |            | 10650020IB | 10"      | 20'    | Solid             |
| 10110020  | 10110020IB |            | 10"      | 20'    | Perforated        |
| 10230020  | 10230020IB |            | 10"      | 20'    | Perforated w/sock |

| Plain End | Soil Tight | Watertight | Diameter | Length | Wall Type         |
|-----------|------------|------------|----------|--------|-------------------|
| 12950020  | 12850020IB | 12650020IB | 12"      | 20'    | Solid             |
| 12910020  | 12810020IB |            | 12"      | 20'    | Perforated        |
| 12930020  | 12830020IB |            | 12"      | 20'    | Perforated w/sock |
| 15950020  | 15850020IB | 15650020IB | 15"      | 20'    | Solid             |
| 15910020  | 15810020IB |            | 15"      | 20'    | Perforated        |
| 15930020  | 15830020IB |            | 15"      | 20'    | Perforated w/sock |
| 18950020  | 18850020IB | 18650020IB | 18"      | 20'    | Solid             |
| 18910020  | 18810020IB |            | 18"      | 20'    | Perforated        |
| 18930020  | 18830020IB |            | 18"      | 20'    | Perforated w/sock |
| 24950020  | 24850020IB | 24650020IB | 24"      | 20'    | Solid             |
| 24910020  | 24810020IB |            | 24"      | 20'    | Perforated        |
| 24930020  | 24830020IB |            | 24"      | 20'    | Perforated w/sock |
| 30950020  | 30850020IB | 30650020IB | 30"      | 20'    | Solid             |
| 30910020  | 30810020IB |            | 30"      | 20'    | Perforated        |
| 30930020  | 30830020IB |            | 30"      | 20'    | Perforated w/sock |
| 36950020  | 36850020IB | 36650020IB | 36"      | 20'    | Solid             |
| 36910020  | 36810020IB |            | 36"      | 20'    | Perforated        |
|           | 36830020IB |            | 36"      | 20'    | Perforated w/sock |
| 42950020  | 42850020IB | 42650020IB | 42"      | 20'    | Solid             |
| 42910020  | 42810020IB |            | 42"      | 20'    | Perforated        |
|           | 42830020IB |            | 42"      | 20'    | Perforated w/sock |
| 48950020  | 48850020IB | 48650020IB | 48"      | 20'    | Solid             |
| 48910020  | 48810020IB |            | 48"      | 20'    | Perforated        |
|           | 48830020IB |            | 48"      | 20'    | Perforated w/sock |
| 60950020  | 60850020IB | 60650020IB | 60"      | 20'    | Solid             |
| 60910020  | 60810020IB |            | 60"      | 20'    | Perforated        |
|           | 60830020IB |            | 60"      | 20'    | Perforated w/sock |

## N-12 Dual Wall Pipe (cont.)

### N-12 Dual Wall Pipe (per ASTM F2648)

| Plain End   | Soil Tight    | Water Tight   | Diameter | Length | Wall Type         |
|-------------|---------------|---------------|----------|--------|-------------------|
| 12950020D W | 12850020IBD W | 12650020IBD W | 12"      | 20'    | Solid             |
| 12910020D W | 12810020IBD W |               | 12"      | 20'    | Perforated        |
| 12930020D W | 12830020IBD W |               | 12"      | 20'    | Perforated w/sock |
| 15950020D W | 15850020IBD W | 15650020IBD W | 15"      | 20'    | Solid             |
| 15910020D W | 15810020IBD W |               | 15"      | 20'    | Perforated        |
| 15930020D W | 15830020IBD W |               | 15"      | 20'    | Perforated w/sock |
| 18950020D W | 18850020IBD W | 18650020IBD W | 18"      | 20'    | Solid             |
| 18910020D W | 18810020IBD W |               | 18"      | 20'    | Perforated        |
| 18930020D W | 18830020IBD W |               | 18"      | 20'    | Perforated w/sock |
| 24950020D W | 24850020IBD W | 24650020IBD W | 24"      | 20'    | Solid             |
| 24910020D W | 24810020IBD W |               | 24"      | 20'    | Perforated        |
| 24930020D W | 24830020IBD W |               | 24"      | 20'    | Perforated w/sock |
| 30950020D W | 30850020IBD W | 30650020IBD W | 30"      | 20'    | Solid             |
| 30910020D W | 30810020IBD W |               | 30"      | 20'    | Perforated        |
| 30930020D W | 30830020IBD W |               | 30"      | 20'    | Perforated w/sock |
| 36950020D W | 36850020IBD W | 36650020IBD W | 36"      | 20'    | Solid             |
| 36910020D W | 36810020IBD W |               | 36"      | 20'    | Perforated        |
|             | 36830020IBD W |               | 36"      | 20'    | Perforated w/sock |
| 42950020D W | 42850020IBD W | 42650020IBD W | 42"      | 20'    | Solid             |
| 42910020D W | 42810020IBD W |               | 42"      | 20'    | Perforated        |
|             | 42830020IBD W |               | 42"      | 20'    | Perforated w/sock |
| 48950020D W | 48850020IBD W | 48650020IBD W | 48"      | 20'    | Solid             |
| 48910020D W | 48810020IBD W |               | 48"      | 20'    | Perforated        |
|             | 48830020IBD W |               | 48"      | 20'    | Perforated w/sock |
| 60950020D W | 60850020IBD W | 60650020IBD W | 60"      | 20'    | Solid             |
| 60910020D W | 60810020IBD W |               | 60"      | 20'    | Perforated        |
|             | 60830020IBD W |               | 60"      | 20'    | Perforated w/sock |

ADS has an available app for pipe installation guides. Please go to: [adspipe.com/resources/ads-design-studio/apps](http://adspipe.com/resources/ads-design-studio/apps) to download the correct app for your mobile device.

## Triplewall Pipe

ADS 3000 Triplewall pipe is made from high-density polyethylene (HDPE), which delivers superior value, physical strength and structural design that cannot be matched.

### APPLICATIONS

- Residential drainage
- Sump pump outlet
- Retaining walls
- Curtain drains
- Downspout runoff
- Foundation/footer drainage
- Irrigation
- Parks/golf courses
- Septic leach fields

### FEATURES

- 10' (3 m) lengths available
- Corrosion resistant to acids, alkalies and salts
- Safe, easy, efficient installations without breaking, splitting or cracking
- Constructed with bell-and-spigot ends for soil-tight joints
- HDPE core fully encloses waterway and lateral pillars maintain pipe rigidity



| SKU       | Diameter | Length | Wall Type              |
|-----------|----------|--------|------------------------|
| 0355-0010 | 3"       | 10'    | Solid                  |
| 0352-0010 | 3"       | 10'    | Two-hole perforated    |
| 0455-0010 | 4"       | 10'    | Solid                  |
| 0452-0010 | 4"       | 10'    | Two-hole perforated    |
| 0453-0010 | 4"       | 10'    | Three-hole perforated* |

\*Available in Eastern U.S. only



## Inserta Tee OneFit

ADS Inserta Tee OneFit is a three-piece lateral pipe solution that will fit any type of pipe. The fast and efficient installation will save time when connecting laterals. The fitting is reliable and lowers material and labor costs.



### APPLICATIONS

- Roof drain leaders
- Structures
- Retention/detention
- Storm sewers
- Irrigation
- Nyloplast drain basins
- Rainwater harvesting

### FEATURES

- No need to disturb backfill
- Eliminates glues, epoxies, grout, tightening and retightening of bands
- Matching of internal radius of pipe or structure for minimal penetration
- No straps or clamps that require digging under the mainline pipe
- Reduction in labor hours and pipe materials

For sanitary-grade or custom fitting needs, building a part number is easy. Please use our Inserta Tee Part Finder at [partfinder.insertatee.com](http://partfinder.insertatee.com) or contact [insertasales@adspipe.com](mailto:insertasales@adspipe.com).

| SKU          | Description                                           | Diameter |
|--------------|-------------------------------------------------------|----------|
| 4P2610-12FIT | 4" SDR 26/35 PVC into 10"-12" pipe                    | 4"       |
| 4P2515+FIT   | 4" SDR 26/35 PVC into 15" and larger pipe             | 4"       |
| 4N1210-12FIT | 4" ADS N-12 into 10"-12" pipe                         | 4"       |
| 4N1215+FIT   | 4" ADS N-12 into 15" and larger pipe                  | 4"       |
| 4IPS10-12FIT | 4" IPS/Sch40 PVC into 10"-12" pipe                    | 4"       |
| 4IPS15+FIT   | 4" IPS/Sch40 PVC into 15" and larger pipe             | 4"       |
| R412SAW      | 4½" red hole saw – for cutting plastic mainline pipes | 4"       |
| 6P2610-12FIT | 6" SDR 26/35 PVC into 10"-12" pipe                    | 6"       |
| 6P2515+FIT   | 6" SDR 26/35 PVC into 15" and larger pipe             | 6"       |
| 6N1210-12FIT | 6" ADS N-12 into 10"-12" pipe                         | 6"       |
| 6N1215+FIT   | 6" ADS N-12 into 15" and larger pipe                  | 6"       |
| 6IPS10-12FIT | 6" IPS/Sch40 PVC into 10"-12" pipe                    | 6"       |
| 6IPS15+FIT   | 6" IPS/Sch40 PVC into 15" and larger pipe             | 6"       |
| R612SAW      | 6½" red hole saw – for cutting plastic mainline pipes | 6"       |
| 8P2612-15FIT | 8" SDR 26/35 PVC into 12"-15" pipe                    | 8"       |
| 8P2518+FIT   | 8" SDR 26/35 PVC into 18" and larger pipe             | 8"       |
| 8N1212-15FIT | 8" ADS N-12 into 12"-15" pipe                         | 8"       |
| 8N1218+FIT   | 8" ADS N-12 into 18" and larger pipe                  | 8"       |
| 8IPS12-15FIT | 8" IPS/Sch40 PVC into 12"-15" pipe                    | 8"       |
| 8IPS18+FIT   | 8" IPS/Sch40 PVC into 18" and larger pipe             | 8"       |
| R834SAW      | 8¾" red hole saw – for cutting plastic mainline pipes | 8"       |

## StormTech



StormTech systems provide large capacity to fit a very tight footprint providing developers with more usable land for development. The chambers are injection molded for uniform wall thickness and repeatable quality. The arch design transfers loads to the surrounding backfill providing long-term safety factors.



### APPLICATIONS

- Commercial
- Municipal
- Industrial
- Recreational
- Residential

### FEATURES

- Seven chamber sizes to fit your project
- Promotes deeper root growth for healthier natural playing surfaces
- Provides subsurface drainage systems to maintain playability for synthetic playing surfaces
- Provides safer surfaces for players

| SKU        | Description     | Dimensions (L x W x H) | Nominal Weight | Storage Capacity      |
|------------|-----------------|------------------------|----------------|-----------------------|
| SC160      | SC-160 Chamber  | 85.4" x 25" x 12"      | 24 lb          | 6.85 ft <sup>3</sup>  |
| SC160IEPP  | SC-160 End cap  | 4.4" x 18.6" x 11.7"   | 2 lb           |                       |
| SC310      | SC-310 Chamber  | 85.4" x 34" x 16"      | 35 lb          | 14.7 ft <sup>3</sup>  |
| SC310EPE   | SC-310 End cap  | 9.9" x 29" x 15.6"     | 4 lb           |                       |
| SC740      | SC-740 Chamber  | 85.4" x 51" x 30"      | 75 lb          | 45.9 ft <sup>3</sup>  |
| SC740EPE   | SC-740 End cap  | 12.2" x 45.9" x 29.3"  | 13 lb          |                       |
| DC780      | DC-780 Chamber  | 85.4" x 51" x 30"      | 80 lb          | 46.2 ft <sup>3</sup>  |
| SC740EPE   | DC-780 End cap  | 12.2" x 45.9" x 29.3"  | 13 lb          |                       |
| MC3500     | MC-3500 Chamber | 86" x 77" x 45"        | 135 lb         | 109.9 ft <sup>3</sup> |
| MC3500IEPP | MC-3500 End cap | 25.7" x 77" x 45"      | 50 lb          | 14.9 ft <sup>3</sup>  |
| MC4500     | MC-4500 Chamber | 52" x 100" x 60"       | 130 lb         | 106.5 ft <sup>3</sup> |
| MC4500REPE | MC-4500 End cap | 35.1" x 90.2" x 59.4"  | 135 lb         | 35.7 ft <sup>3</sup>  |
| MC7200     | MC-7200 Chamber | 83" x 100" x 60"       | 205 lb         | 175.9 ft <sup>3</sup> |
| MC7200IEPP | MC-7200 End cap | 38" x 90" x 61"        | 90 lb          | 39.5 ft <sup>3</sup>  |





## Nyloplast

Nyloplast manufactures PVC plastic structures for the stormwater capture market. The full line includes custom fabricated heavy-duty road and highway structures, curb inlet structures, drain basins, inline drains and drop-in grates.

### APPLICATIONS

- Commercial
- Road and highway, parks and recreation, golf courses, residential and institutions

### FEATURES

- Watertight fitting
- Lightweight for safer installation and 3-4 times quicker than precast structures
- Size-on-size pipe-to-basin connections
- Wide selection of grates
- Field adaptable
- Water quality features may be added

Nyloplast's drain basin configurator designs a drain structure quickly and easily online. The drain basin configurator is available at [basinconfigurator.com](http://basinconfigurator.com)

### Nyloplast Drain Basin



| SKU       | Description      | Available Outlets |
|-----------|------------------|-------------------|
| 2808AG__X | 8" Custom basin  | 4"-8"             |
| 2810AG__X | 10" Custom basin | 4"-10"            |
| 2812AG__X | 12" Custom basin | 4"-12"            |
| 2815AG__X | 15" Custom basin | 4"-15"            |
| 2818AG__X | 18" Custom basin | 4"-18"            |
| 2824AG__X | 24" Custom basin | 4"-24"            |
| 2830AG__X | 30" Custom basin | 4"-30"            |

The set of blanks is the number of branches (choose 01-05)  
 The X represents the pipe type adapting to. Replace X with one of the following:  
 N = ADS dual wall pipe  
 D = DWV PVC (Sch 40 or Sch 80)  
 S = SWR PVC (ASTM D3034, SDR 35 SWR & SDR 26 SWR PVC)  
 If branches are mixed (two or more different pipe types) leave X blank.

### Nyloplast Inline Drain



| SKU       | Description      | Available Outlets |
|-----------|------------------|-------------------|
| 2708AG__X | 8" Inline drain  | 4"-8"             |
| 2710AG__X | 10" Inline drain | 4"-10"            |
| 2712AG__X | 12" Inline drain | 4"-12"            |
| 2715AG__X | 15" Inline drain | 4"-15"            |
| 2718AG__X | 18" Inline drain | 4"-18"            |
| 2724AG__X | 24" Inline drain | 4"-24"            |
| 2730AG__X | 30" Inline drain | 4"-30"            |

The set of blanks is the pipe size adapting to (choose from 04, 06, 08, 10, 12, 15, 18, 24 or 30)  
 The X represents the pipe type adapting to. Replace X with one of the following:  
 N = ADS dual wall pipe  
 D = DWV PVC (Sch 40 or Sch 80)  
 S = SWR PVC (ASTM D3034, SDR 35 SWR & SDR 26 SWR PVC)  
 If branches are mixed (two or more different pipe types) leave X blank.

### Nyloplast Blank Basin with H-20 Grate

| SKU    | Description  |
|--------|--------------|
| 2808AG | 8" Diameter  |
| 2810AG | 10" Diameter |
| 2812AG | 12" Diameter |
| 2815AG | 15" Diameter |
| 2818AG | 18" Diameter |
| 2824AG | 24" Diameter |

### Grates for Drain Basins & Inline Drains

**Formula for ordering grates: \_\_CGX**  
 The blanks are grate size (choose from 08, 10, 12, 15, 18, 24 or 30)  
 X = Style. Choose from:  
 S = Standard  
 SL = Standard locking  
 P = Pedestrian (available in 8"-24")  
 PL = Pedestrian locking (available in 8"-24")  
 C = Solid  
 CL = Solid locking  
 B = Bronze (available in 8"-15")  
 BL = Bronze locking (available in 8"-15")  
 D = Domed  
 DL = Domed locking



### Drop-In Grates

**Formula for ordering grates: \_\_01DI**  
 The blanks are grate size (choose from 06, 08, 10, 12, 15, 18 or 24)



Universal Inline Drain™ with 12" standard grate

## Universal Inline Drain™

### Announcing Nyloplast's newest stormwater management solution - the Universal Inline Drain

Engineered for custom connection right off the shelf, the Universal Inline Drain provides a flexible design that adapts to various pipe sizes, grates and covers. The drain provides flexibility and ground support you need to get the project done faster and with long-lasting performance in mind.

#### APPLICATIONS

- Commercial
- Road and highway
- Parks and recreation
- Golf courses
- Residential
- Institutions

#### FEATURES

- Injection-molded eliminates joint connections for leak-free performance
- Stepped bell connects to commonly stocked 6"-12" plastic pipe - HDPE or PVC
- Lightweight for safer installation and four times faster installation
- Tapered flow eliminates standing water
- Field adjusted with common tools
- 80% reduction in parts for easier ordering and stocking
- 100-year service life on PVC
- Off-the-shelf connection to multiple grate sizes (with a 6" pre-cut outlet)
  - 12" drop-in
  - 12" standard
  - 12" pedestrian
  - 12" dome

| SKU      | Description         | Connection |
|----------|---------------------|------------|
| 2712AGNB | 6"-12" Inline drain | HDPE       |
| 2712AGSB | 6"-12" Inline drain | PVC        |

## Geotextiles

### ADS has a full line of available geotextiles

Non-woven geotextiles are used to filter solid particles on drainage systems.

#### APPLICATIONS

- Subsurface drainage
- Underground retention/detention systems
- Roadway separation
- Hard armour underlayment



#### FEATURES

- Provides excellent filter in subsurface drainage applications
- Prevent fine soil particles from entering pipe
- Prevents soil intrusion into backfill/water storage area

### Geosynthetics – Nonwoven

| SKU    | Weight | W x L        | SY/Roll |
|--------|--------|--------------|---------|
| 0351TG | 3.5 oz | 12.5' x 360' | 500     |
| 0351TS | 3.5 oz | 15' x 360'   | 600     |
| 0401TG | 4.0 oz | 12.5' x 360' | 500     |
| 0401TS | 4.0 oz | 15' x 360'   | 600     |
| 0451TG | 4.5 oz | 12.5' x 360' | 500     |
| 0451TS | 4.5 oz | 15' x 360'   | 600     |
| 0601TG | 6.0 oz | 12.5' x 360' | 500     |
| 0601TS | 6.0 oz | 15' x 300'   | 500     |

Woven geotextiles feature high tensile strengths to distribute loads and extend the life of paved and unpaved roadways.

#### APPLICATIONS

- Paved roadways
- Unpaved roadways



#### FEATURES

- Distribute loads over a wider foundation
- Reduce rutting
- Prevents subgrade from intruding into aggregate

### Geosynthetics – Woven

| SKU    | Grab Tensile | W x L        | SY/Roll |
|--------|--------------|--------------|---------|
| 200WTK | 200          | 12.5' x 432' | 600     |
| 200WTS | 200          | 15' x 360'   | 600     |
| 200WTM | 200          | 17.5' x 309' | 600     |



## BAM! Ground Protection Mats

Versatile, safe and durable site protection to save you time and money

### FEATURES

- Exclusive dual-side traction design
- Interlocking tread designs
- Available in two sizes
- Cost effective compared to plywood
- Light: 4' x 8' sheet weighs 56 lb
- Test rated at 53,712 lb per sq. ft.
- Doesn't absorb sunlight, prevents turf browning
- Resists cutting and fading
- Mitigates unnecessary site damage
- Reusable – weight, color and shape remain consistent over mat's lifetime
- 4' x 8' (1.2 x 2.4 m) sheet weighs only 56 lb (25 kg) and rated at 160,000 lb (72,574 kg)\*
- Hand holes on the 4' x 8' (1.2 x 2.4 m) for easy loading and unloading
- 3/8" thickness vs. competitor's 1/2" sheet, which weighs 90 lb (40 kg)
- Won't absorb chemicals and moisture. Rinse with soapy water and reuse.
- Manufactured in the USA with a three-year manufacturer's limited warranty

\* Rating subject to ground conditions



Equipment side

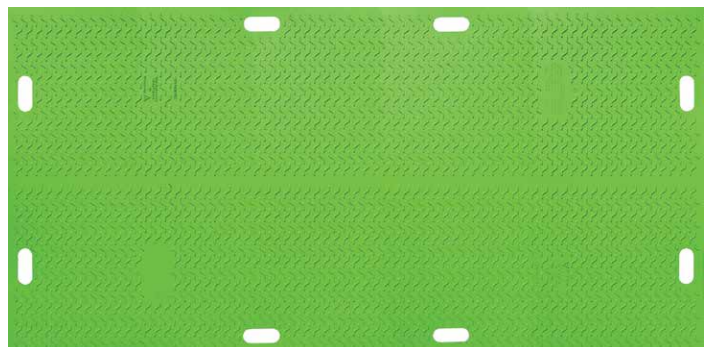

Pedestrian side

| SKU      | Description                        |
|----------|------------------------------------|
| 24040820 | 4' x 8' BAM! ground protection mat |

## AdvanEdge Pipe

ADS AdvanEdge pipe consists of a perforated panel-shaped plastic core and is available in 12" (300 mm) oblong dimensions. Panel pipe has twice the soil contact of round pipe and will drain a given quantity of water in about 60% of the time.

### APPLICATIONS

- Athletic turf drainage/golf course
- Building foundations
- Retaining walls
- Edge drains

### FEATURES

- Slim 1.5" (38 mm) invert design permits significantly higher flow velocity at lower head
- Slim-line design allows for narrow trench installation
- Fast installation times
- HDPE core fully encloses waterway and lateral pillars maintain pipe rigidity



### AdvanEdge Pipe

| SKU      | Description     | Diameter | Length |
|----------|-----------------|----------|--------|
| 04900100 | No fabric       | 12"      | 100'   |
| 04930100 | 4.0 oz spunbond | 12"      | 100'   |

### AdvanEdge Pipe Fittings

| SKU     | Description            | Diameter |
|---------|------------------------|----------|
| 1432AA  | Snap end cap           | 12"      |
| 1411AA  | External split coupler | 12"      |
| 1480AA  | Wye                    | 12"      |
| 0840MB  | Coupling pin (2/pack)  | 12"      |
| 1472AA  | End outlet             | 12"      |
| 1471AA  | Side outlet            | 12"      |
| 14432AN | Flat outlet            | 12"      |
| 1480AN  | Vertical wye           | 12"      |
| 1460AN  | Vertical tee           | 12"      |
| 1460ANH | Horizontal tee         | 12"      |

## TurfFlow Pipe

TurfFlow is a 2" (50 mm) diameter pipe that can be installed with minimal turf disruption. It is available in solid, wide and narrow slot.

### APPLICATIONS

- Golf courses
- Playgrounds/parks
- Edge drains
- Residential
- Sports playing fields
- Landscaping
- Walkways

### FEATURES

- Available in rolls up to 500' (150 m) in length
- Excellent abrasion and corrosion resistance
- Flexible and light weight
- Fast installation time
- Maximum playability
- Reduced risk of turf disease



### TurfFlow Pipe

| SKU         | Description      | Diameter | Length |
|-------------|------------------|----------|--------|
| 02510050    | Solid            | 2"       | 50'    |
| 02010050    | Wide slot        | 2"       | 50'    |
| 02510025H   | Solid            | 2"       | 100'   |
| 02010100H   | Wide slot        | 2"       | 100'   |
| 02730118H   | Wide slot w/wrap | 2"       | 118'   |
| 02010300    | Wide slot        | 2"       | 300'   |
| 02510500NSH | Narrow slot      | 2"       | 500'   |

### TurfFlow Pipe Fittings

| SKU    | Description     | Package Quantity |
|--------|-----------------|------------------|
| 0212AA | Coupler         | 50               |
| 0232AA | End cap         | 50               |
| 0241AA | Blind tee/elbow | 50               |
| 0214AA | Reducer         | 25               |
| 0221AA | Tee             | 50               |

## 2" TurfFlow Perforated Pipe

TurfFlow 2" (50 mm) diameter pipe is perfect for quick drainage. Its flexibility allows it to be used in many applications other pipes cannot. Available in solid, wide and narrow slot, the pipe easily connects with a full line of twist-on fittings.



### FEATURES

- Maximum playability
- Long-term effective drainage
- Installation with minimal turf disruption
- Reduced compaction
- 2" (50 mm) diameter x 500' length

| SKU    | Description                 |
|--------|-----------------------------|
| DL1500 | 2" TurfFlow perforated pipe |

## 2" TurfFlow Coupler

The TurfFlow Coupler lets you connect two sections of TurfFlow pipe. Made with high-grade HDPE materials, this coupling ensures durability. The 2" coupler screws onto 2" TurfFlow pipe for a quick and easy setup.



### FEATURES

- Maximum playability
- Twist connection with TurfFlow pipe
- Long-term effective drainage
- Installation with minimal turf disruption
- Reduced compaction
- 2" (50 mm) diameter

| SKU    | Description         |
|--------|---------------------|
| DL2000 | 2" TurfFlow coupler |

## 2" TurfFlow End Cap

The TurfFlow end cap lets you cap a run of TurfFlow pipe. Made with high-grade HDPE materials, this cap ensures durability. The 2" cap screws onto 2" TurfFlow pipe for a quick and easy setup.



### FEATURES

- Maximum playability
- Twist connection with TurfFlow Pipe
- Long-term effective drainage
- Installation with minimal turf disruption
- Reduced compaction
- 2" (50 mm) diameter

| SKU    | Description         |
|--------|---------------------|
| DL2100 | 2" TurfFlow end cap |

## 2" TurfFlow Tee/Elbow

The TurfFlow tee/elbow is a blind tee that can function as an elbow or as a tee when the end cap is cut. This allows for multiple styles of junctions when connecting TurfFlow pipe. Made with high-grade HDPE materials, this tee ensures durability. The 2" tee screws onto 2" TurfFlow pipe for a quick and easy setup.



### FEATURES

- Maximum playability
- Twist connection with TurfFlow pipe
- Long-term effective drainage
- Installation with minimal turf disruption
- Reduced compaction
- 2" (50 mm) diameter

| SKU    | Description           |
|--------|-----------------------|
| DL2200 | 2" TurfFlow tee/elbow |

## 2" TurfFlow 4"x 2" Reducer

The TurfFlow 4" x 2" reducer lets you connect pipes of different diameters. Made with high-grade HDPE materials, this reducer coupling ensures durability. The 4" end snaps onto standard 4" pipe, while the 2" end screws onto 2" TurfFlow pipe for a quick and easy setup.



### FEATURES

- Maximum playability
- Twist connection with TurfFlow Pipe
- Long-term effective drainage
- Installation with minimal turf disruption
- Reduced compaction
- 2" (50 mm) diameter

| SKU    | Description                |
|--------|----------------------------|
| DL2300 | 2" TurfFlow 4"x 2" reducer |

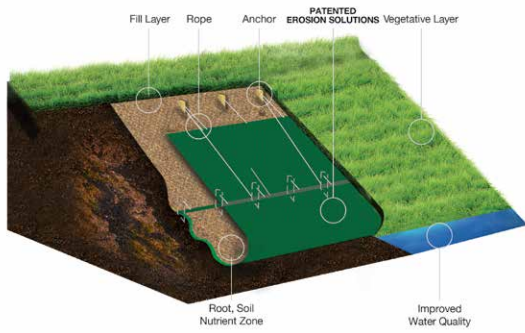

## DredgeSOX™ / ShoreSOX™ Erosion Control Systems

SOX Erosion Solutions™ specializes in developing, producing, and delivering patented bioengineered systems tailored to halt and restore shoreline and hillside erosion, simultaneously fostering growth of vegetation.

SOX' erosion control systems are crafted with our patented knitted technical mesh, featuring a ripstop technology, and built-in anchoring system. The systems are lightweight, resilient, modular and flexible in design, enhancing it's overall effectiveness.



### Take Control of Erosion

Combat erosion effectively with DredgeSOX™ and ShoreSOX™. These systems do require in-field training before becoming a certified service provider.

Upon setup, SOX' systems establish a robust green infrastructure. It's the ideal solution for projects involving water bodies like lakes and creek beds. ShoreSOX™ and DredgeSOX™ are lightweight market solutions that protect the surrounding property and it's stakeholders.

### FEATURES

- Subsurface anchoring
- Integrates with existing slope
- Lightweight (labor and logistics)
- Modular
- Knitted ripstop material design
- Long-term stability
- Improves runoff water quality (surface and subsurface)
- Supports root vegetation and plant growth
- Eliminates edge erosion
- Reclaim lost land
- Captures soil nutrients
- Made in the USA
- Patented

| SKU          | Description          | Size       | Color |
|--------------|----------------------|------------|-------|
| DSXT2T12X100 | DredgeSOX / ShoreSOX | 12' x 100' | Tan   |
| DSXT2T12X200 | DredgeSOX / ShoreSOX | 12' x 200' | Tan   |
| DSXT2T6X100  | DredgeSOX / ShoreSOX | 6' x 100'  | Tan   |
| DSXT2T6X200  | DredgeSOX / ShoreSOX | 6' x 200'  | Tan   |
| DSXT2G12X100 | DredgeSOX / ShoreSOX | 12' x 100' | Green |
| DSXT2G12X200 | DredgeSOX / ShoreSOX | 12' x 200' | Green |
| DSXT2G6X100  | DredgeSOX / ShoreSOX | 6' x 100'  | Green |
| DSXT2G6X200  | DredgeSOX / ShoreSOX | 6' x 200'  | Green |



## EvoGuard™ DIY Kit and EvoGuard Pro™

EvoGuard™ is a multifunctional protective project barrier that retains silt and sediments, slows water encroachment and serves as a containment barrier for mudslides and debris flow, soil erosion, windblown sand, snow drifts and other land encroachment threats. EvoGuard™ is a trenchless design that is strengthened as solids accumulate onto the system. The barrier shields against surface water, moderating its impact and distributing it evenly at a less destructive rate. Affected slopes are given the opportunity to revegetate and restabilize, delivering both instant protection and a long-term erosion solution.

**EvoGuard™ DIY Kit:** Comes with all supplies needed for installation, 2' height, 50' & 100' lengths, tan or green

**EvoGuard™ Pro:** 1', 2', and 3' heights, 50' & 100' lengths, tan or green, bulk orders for large commercial projects

### FEATURES

- High static bursting strength; can withstand over 22,000 ppsf
- Fire-resistant, non-accelerant
- UV protected
- Ripstop technology – doesn't unravel
- Integrated post sleeves and roping channels for maximized structural integrity

| SKU                     | Description      | Size      | Color |
|-------------------------|------------------|-----------|-------|
| <b>EvoGuard DIY Kit</b> |                  |           |       |
| EVOBAR50T               | EvoGuard DIY kit | 2' x 50'  | Tan   |
| EVOBAR100T              | EvoGuard DIY kit | 2' x 100' | Tan   |
| EVOBAR50G               | EvoGuard DIY kit | 2' x 50'  | Green |
| EVOBAR100G              | EvoGuard DIY kit | 2' x 100' | Green |
| <b>EvoGuard Pro</b>     |                  |           |       |
| EVOPRO1X50T             | EvoGuard Pro     | 1' x 50'  | Tan   |
| EVOPRO1X100T            | EvoGuard Pro     | 1' x 100' | Tan   |
| EVOPRO2X50T             | EvoGuard Pro     | 2' x 50'  | Tan   |
| EVOPRO2X100T            | EvoGuard Pro     | 2' x 100' | Tan   |
| EVOPRO2X50G             | EvoGuard Pro     | 2' x 50'  | Green |
| EVOPRO2X100G            | EvoGuard Pro     | 2' x 100' | Green |
| EVOPRO3X50T             | EvoGuard Pro     | 3' x 50'  | Tan   |
| EVOPRO3X100T            | EvoGuard Pro     | 3' x 100' | Tan   |
| EVOPRO3X50G             | EvoGuard Pro     | 3' x 50'  | Green |
| EVOPRO3X100G            | EvoGuard Pro     | 3' x 100' | Green |

# Water Conservation





## Soil Sensors

### Proactive soil management and water conservation solution

The leading soil sensor solution in the golf industry. Average customer annual water savings equals 25%.

**Save water:** Reduce water usages and transform into a sustainable organization.

**Save the soil:** Reduce water run times to preserve soil health and improve growing conditions.

**Save Money:** Save on water costs, decrease energy use and pumping costs, and optimize you labor to save big.

### FEATURES

- Measures moisture, salinity and ground temperature
- Cellular data connectivity + GPS + Bluetooth. No wires. No infrastructure required.
- Robust reporting with historical data graphs
- Set thresholds and alerts based on soil and grass type
- Web and mobile applications for real-time access
- Quick and easy installation
- Simple to use admin features to manage sensors, users and multiple facilities



| SKU               | Description                                             |
|-------------------|---------------------------------------------------------|
| GX-1A Soil Sensor | Installed at ground level or 2" to 4" deep              |
| GX-1F Soil Sensor | Installed up to 42" deep using flexible tethered sensor |

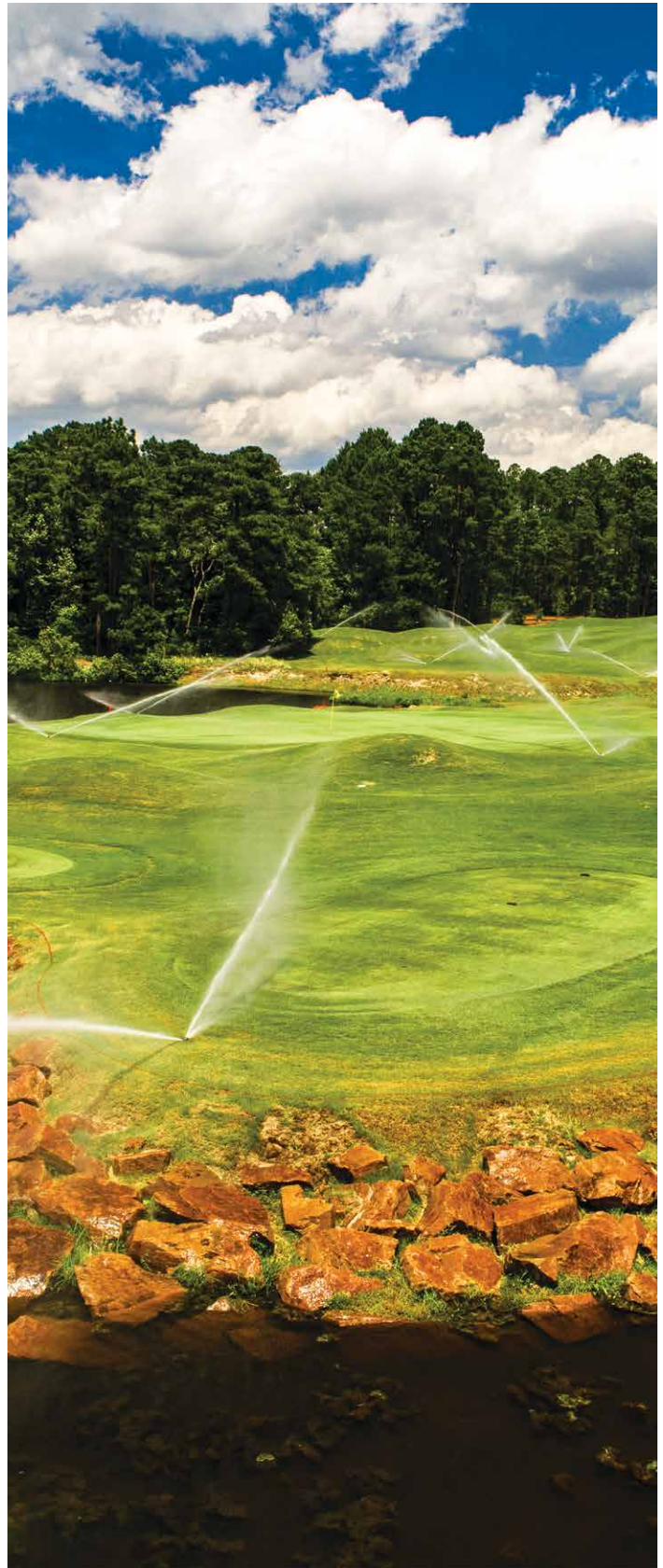



## ClearWater Wash Water Recycling System

### FEATURES

- ClearWater is the No. 1 underground wash water recycling system
- Helps keep you compliant and avoids pollution
- Utilized on golf courses and in sports facilities, specifically designed for the fine turf industry
- The advanced water recycling system utilizes harmless micro-organisms to clean contaminated water from washdown areas and therefore requires minimal maintenance with exceptionally low running costs
- Choose from either 1,320- or 2,640-gallon, leak-free and corrosion-resistant tank, with anything between 2-4 hose outlets all supplying up to 120psi of pressure
- Below ground and out of sight, this system deters vandalism and is protected from UV rays, helping maintain a stable low temperature and reducing the risk of harmful bacteria production
- Utilize an existing wash pad or design your own with our unique grass or silt traps to suit any shape or size pad
- Reuses up to 90% of water and saves on average up to 132,100 gallons of water per year

**Contact your local Ewing representative for further information and pricing.**



# Turf and Ornamental



## Turf and Ornamental

At Ewing Outdoor Supply you can LEAN ON US for all your turf and ornamental solutions. We are here to serve your needs with solutions for any course input, large or small, from fertilizer, combination products, control products, seed, to equipment and much more.

Our commitment is to put the customer first, with impeccable service aligned with seasonal order and purchase options that help you operate within your budget.

We have the flexibility to allow you to make the right buying decision regardless of geography, season, or application requirement.

## Granular Fertilizer

| SKU      | Description                    |
|----------|--------------------------------|
| 51098000 | EMPRO 0-0-24 KMAG/MINORS/HUMIC |
| 51130010 | EMPRO 46-0-0 SPRAYABLE UFLEX   |
| 51130600 | EMPRO 34-3-7 ALL MINERAL       |
| 51130700 | EMPRO 32-0-0 30%UFLEX 25%AS    |
| 51130710 | EMPRO 32-0-0 30% UFLEX         |
| 51130720 | EMPRO 32-0-0 30%PCU 25%AS      |
| 51130750 | EMPRO 32-0-4 50NSN 4FE         |
| 51131000 | EMPRO 28-3-10 50%UFEXXWOLFTRAX |
| 51131010 | EMPRO 28-0-0 50% UFLEX 5% FE   |
| 51131400 | EMPRO 24-0-10 50UFLEX452FE1MN  |
| 51131410 | EMPRO 24-0-8 40% UFLEX         |
| 51131420 | EMPRO 24-0-8 50%XCU 6FE        |
| 51131650 | EMPRO 22-0-6 25PCU .17 DIMENS  |
| 51131800 | EMPRO 20-0-8 50% UFLX WFTX GYP |
| 51131900 | EMPRO 19-19-19 ALL MINERAL     |
| 51131950 | EMPRO 19-0-5 50XCU 3FE .29PROD |
| 51132000 | EMPRO 18-18-18 HYDROMULCH FERT |
| 51132010 | EMPRO 18-24-12 ALL MINERAL     |
| 51132040 | EMPRO 18-7-9 DURAGEM           |
| 51132050 | EMPRO 18-6-12 ORNAMENTAL       |
| 51132080 | EMPRO 18-5-0 5%FE              |
| 51132090 | EMPRO 18-0-4 25XCU .37 PROD    |
| 51132100 | EMPRO 17-5-10 W/TRACE PKG      |
| 51132110 | EMPRO 17-5-9 10S 3FE.3ZN       |
| 51132220 | EMPRO 16-2-3 66% NUTRIPEL      |
| 51132230 | EMPRO 16-2-3 45%UFLEX 2FE BIO  |
| 51132240 | EMPRO 16-2-3 45%PCU 2FE BIO    |



| SKU      | Description                    |
|----------|--------------------------------|
| 51132250 | EMPRO 16-4-8 40%SCU 2FE        |
| 51132260 | EMPRO 15-15-15 HYDROMULCH FERT |
| 51132300 | EMPRO 15-15-15 HYDROMULCH FERT |
| 51132350 | EMPRO 15-0-15 45%JLEX 6%FE     |
| 51132400 | EMPRO 14-14-14 ORNAMENTAL      |
| 51132410 | EMPRO 14-14-14 DURAGEM         |
| 51132450 | EMPRO 14-7-7 ORNAMENTAL        |
| 51132460 | EMPRO 14-7-7 60%NITROSOPHOUMIC |
| 51132500 | EMPRO 13-13-13                 |
| 51132600 | EMPRO 12-12-12 ALL MINERAL     |
| 51132800 | EMPRO 10-20-10                 |
| 51133300 | EMPRO 5-10-31 5% FE            |
| 51133320 | EMPRO 5-5-25 5%FE              |
| 51133330 | EMPRO 5-5-25 .17 DIMENSION     |
| 51133350 | EMPRO 5-0-31 20%NS-54 10%FE    |
| 51133360 | EMPRO 5-0-20 .29 PRODIAMINE    |
| 51133600 | EMPRO 6LB 2-4-3 PLANT START    |
| 51133650 | EMPRO 0-0-7 .17 DIMENSION      |
| 51133660 | EMPRO 0-0-7 .37 PRODIAMINE     |
| 51133670 | EMPRO 0-0-7 .43 PRODIAMINE     |
| 51133700 | EMPRO 50LB 22-0-22             |
| 51793060 | EMPRO 15-15-15                 |
| 51793065 | EMPRO 16-6-8                   |
| 51793070 | EMPRO 18-5-0 5%FE              |
| 51793080 | EMPRO 21-2-4                   |
| 51793085 | EMPRO 22-4-10                  |
| 51793090 | EMPRO 25-5-5                   |
| 51793095 | EMPRO 6-24-24                  |
| 51793100 | EMPRO 9-9-9                    |
| 51793105 | EMPRO 16-2-3 60%SRN            |
| 51793110 | EMPRO 22-5-10                  |
| 51793115 | EMPRO 12-0-2                   |
| 51793145 | EMPRO 16-6-8 TRIMEC            |



## Combination Products

| SKU      | Description                     |
|----------|---------------------------------|
| 51131650 | EMPRO 22-0-6 25PCU .17 DIMENSN  |
| 51131950 | EMPRO 19-0-5 50XCU 3FE .29PROD  |
| 51132090 | EMPRO 18-0-4 25XCU .37 Prod     |
| 51132260 | EMPRO 16-0-16 40PCU3FE .29 Prod |
| 51133330 | EMPRO 5-5-25 .17 Dimension      |
| 51133360 | EMPRO 5-0-20 .29 Prodiamine     |
| 51133650 | EMPRO 0-0-7 .17 Dimension       |
| 51133660 | EMPRO 0-0-7 .37 Prodiamine      |
| 51133670 | EMPRO 0-0-7 .43 Prodiamine      |
| 51793145 | EMPRO 16-6-8 Trimec             |

## Liquid Fertilizer

| SKU      | Description               |
|----------|---------------------------|
| 51140202 | EMPRO DuraArmor 2.5 gal   |
| 51140250 | EMPRO 1GL Clear Iron 5%   |
| 51140260 | EMPRO 2.5GL Clear Iron 5% |
| 51140300 | EMPRO 2.5GL Micro Mix     |
| 51140330 | EMPRO 30GL Micro Mix      |
| 51140350 | EMPRO 250GL Micro Mix     |
| 51140400 | EMPRO 2.5GL 30-0-0        |
| 51140410 | EMPRO 250GL 30-0-0        |
| 51140500 | EMPRO 2.5GL 18-3-3 Micros |
| 51140530 | EMPRO 30GL 18-3-3 Micros  |
| 51140600 | EMPRO 2.5GL 16-0-4 Thrive |
| 51140630 | EMPRO 30GL 16-0-4 Thrive  |
| 51140700 | EMPRO 2.5GL 13-0-0 Revive |
| 51140730 | EMPRO 30GL 13-0-0 Revive  |
| 51140750 | EMPRO 250GL 13-0-0 Revive |
| 51140800 | EMPRO 2.5GL 8-8-8 Ignite  |
| 51140900 | EMPRO 2.5GL 0-0-25        |
| 51140930 | EMPRO 30GL 0-0-25         |
| 51141050 | EMPRO 1GL Clear MN 9%     |
| 51141060 | EMPRO 2.5GL Clear MN 9%   |
| 51141100 | EMPRO 250GL AER8TION      |
| 51141102 | EMPRO 2.5GL AER8TION      |
| 51141130 | EMPRO 30GL AER8TION       |

## Additives

| SKU      | Description                      |
|----------|----------------------------------|
| 52501012 | EMPRO green pigment 1 gal        |
| 52501023 | EMPRO green turf paint 2.5 gal   |
| 52501212 | EMPRO green indicator 1 gal      |
| 52501213 | EMPRO green indicator 2.5 gal    |
| 52501220 | EMPRO blue indicator 1 qt        |
| 52501222 | EMPRO blue indicator 1 gal       |
| 52501223 | EMPRO blue indicator 2.5 gal     |
| 52501512 | EMPRO adjuvant 90/10 1 gal       |
| 52501513 | EMPRO adjuvant 90/10 2.5 gal     |
| 52501533 | EMPRO adjuvant 80/20 2.5 gal     |
| 52501563 | EMPRO methylated seed oil 2.5gal |
| 52501810 | EMPRO defoamer 1 qt              |
| 52501820 | EMPRO tank cleaner 1 qt          |
| 52501913 | EMPRO Sunspray fine oil 2.5 gal  |
| 52501915 | EMPRO Sunspray fine oil 55 gal   |
| 52501950 | EMPRO spreader / sticker 2.5 gal |
| 62501210 | EMPRO blue coloring WSB 24/CS    |
| 62501212 | EMPRO blue coloring 1 gal        |
| 62501230 | EMPRO black coloring WSB 24/CS   |
| 62501232 | EMPRO black coloring 1 gal       |

Scan the QR Code and let us know how we can help you.



## TRADITION®

FINE FESCUE MIXTURE

### Tradition® Fine Fescue Seed

Tradition fine fescue seed is used on golf courses for high-quality turf on shaded tees or fairways, and to create a links-look in out-of-play or native-style roughs. This mixture of fine fescue species is designed for tough conditions with a high tolerance of salt and poor soils, as well as a high disease tolerance using varieties from the A-LIST™ (Alliance for Low Input Sustainable Turf). Extended active green growing season improves the overall performance.

| SKU      | Description                 |
|----------|-----------------------------|
| 53000647 | Tradition® fine fescue seed |

## WORLD CUP

KENTUCKY BLUEGRASS BLEND

### World Cup Bluegrass Seed

World Cup bluegrass seed works hard for the northern turf manager and golf superintendent at higher elevations throughout North America. Blending superior Kentucky bluegrass genetics for the most up-to-date performance under any level of play and maintenance. Noted for high disease resistance and high wear tolerance for tees, fairways and mowed roughs. World Cup bluegrass seed can be planted with Remedy or Candidame ryegrass as a nurse crop to speed up establishment and get a new fairway or tee into play sooner.

| SKU      | Description              |
|----------|--------------------------|
| 53001407 | World Cup bluegrass seed |

## DOMINATOR

CREEPING BENTGRASS BLEND

### Dominator Bentgrass Seed

Dominator bentgrass seed is a high-performance, scientifically formulated blend of Super Bents™ varieties of creeping bentgrass. Designed for courses throughout North America, Dominator can be planted on new greens, tees and fairways or interseeded into existing bentgrass or bent/Poa annua greens, tees and fairways to improve performance and golfing quality on any course.

| SKU      | Description              |
|----------|--------------------------|
| 53004036 | Dominator bentgrass seed |

## EMPRO™

### Ace

### EMPRO™ Ace Perennial Ryegrass Seed

EMPRO™ Ace perennial ryegrass seed is a top performance choice for golf superintendents throughout North America. This blend includes highly rated varieties from the A-LIST™ and 4turf™ breeding programs of DLF USA, which are developed to perform in stressful conditions. High disease resistance, along with spreading rhizomes and aggressive tillering for increased density and recovery from wear and high use, makes EMPRO™ Ace ryegrass from DLF a top choice for golf tees, fairways and roughs throughout North America.

| SKU      | Description                        |
|----------|------------------------------------|
| 53000010 | EMPRO™ Ace perennial ryegrass seed |



## 200- & 300-Gallon Truck Mounted Units



### FEATURES

- All in one
- Just add spray gun
- P530 piston pump with Honda GX160 manual start
- Electric reel
- 400' x 3/8" hose

| SKU            | Description                    |
|----------------|--------------------------------|
| 21-82SS61-P530 | 200-gallon space saver sprayer |
| 21-83SS61-P530 | 300-gallon space saver sprayer |

## 75- & 100-Gallon UTV Molded Tank Units



### FEATURES

- Add accessories, spray gun, boom, reel package
- P530 piston pump Honda with GX160 manual start

| SKU            | Description            |
|----------------|------------------------|
| 21-87UTXX-P530 | 75-gallon UTV sprayer  |
| 21-81UTXX-P530 | 100-gallon UTV sprayer |

## Booms

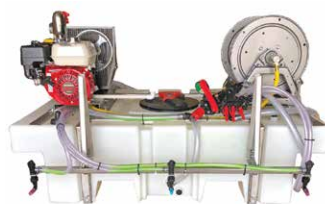

| SKU        | Description                                                                                                               |
|------------|---------------------------------------------------------------------------------------------------------------------------|
| 23-850010  | 4' three-nozzle boom with individual boom nozzle control                                                                  |
| 23-85004   | 16' three-section boom with manual boom control. Control each section with individual on/off control.                     |
| 23-85002   | 16' three-section boom with electronic boom control. Control each section with individual on/off control.                 |
| 23-85001-B | Boom accessory: 2" hitch assembly for 4' and 16' boom                                                                     |
| 23-85000-A | Two-nozzle boomless boom with swing arm access for easy UTV driver control. Made to mount directly on UTV molded tanks.   |
| 23-85001-A | Boom accessory: 2" hitch assembly for two-nozzle adjustable spray boom                                                    |
| 23-85006   | Boom: P530 single direct valve system to operate boom in cab. Includes 15' of wire with toggle switch for remote mounting |

## Hose Reel Packages



| SKU           | Description                             |
|---------------|-----------------------------------------|
| 53-BHAE1520-2 | 12" electric reel with 200' x 3/8" hose |
| 53-BHAE1526-1 | 12" electric reel with 400' x 3/8" hose |

## Spray Guns



| SKU        | Description                                                                                                                                       |
|------------|---------------------------------------------------------------------------------------------------------------------------------------------------|
| 81-855-00E | Ewing Do-All Kit (0-20 GPM- 0-800 psi) Large tip installed and additional S-M-XL tip plus shower head S-M-L nozzles with stainless-steel inserts. |
| 11-857-01  | Mag-2000 lawn gun kit                                                                                                                             |

## 100 lb Ice Melt Spreader

### FEATURES

- 100 lb capacity
- Stainless-steel frame
- High output opening
- 13" pneumatic tires



| SKU   | Description              |
|-------|--------------------------|
| 92170 | 100 lb Ice melt spreader |

## 100 lb Professional Broadcast Spreader

### FEATURES

- 100 lb capacity
- Stainless-steel frame
- Side-spread control (no need to add deflector)
- 13" pneumatic tires



| SKU   | Description                            |
|-------|----------------------------------------|
| 21710 | 100 lb Professional broadcast spreader |

## 50 lb Professional Broadcast Spreader

### FEATURES

- 50 lb capacity
- Stainless-steel frame
- Side-spread control (no need to add deflector)
- 13" pneumatic tires



| SKU   | Description                           |
|-------|---------------------------------------|
| 21705 | 50 lb professional broadcast spreader |

## 80 lb Professional Broadcast Spreader

### FEATURES

- 80 lb capacity
- Heavy-duty frame
- Side-spread control (no need to add deflector)
- 13" pneumatic tires



| SKU   | Description                           |
|-------|---------------------------------------|
| 21708 | 80 lb professional broadcast spreader |

## 25 lb Bag Seeder/Spreader

### FEATURES

- 25 lb capacity
- Nylon construction
- High-speed gearbox



| SKU  | Description               |
|------|---------------------------|
| 2750 | 25 lb bag seeder/spreader |

## 40 lb Chest Mount Spreader

### FEATURES

- 40 lb capacity
- Factory-sealed and lubricated gearbox
- Side-spread control (no need to add deflector)



| SKU  | Description                |
|------|----------------------------|
| 3100 | 40 lb chest mount spreader |

## 4 lb Hand Spreader with Armrest

### FEATURES

- 4 lb capacity
- Built-in ergonomic armrest
- Scoop design to easily fit into 5 gal bucket



| SKU   | Description                     |
|-------|---------------------------------|
| 16124 | 4 lb hand spreader with armrest |

## EarthShaker Hand Spreader

### FEATURES

- 4 lb capacity
- Easily dial in opening size to match granular size
- Clicks closed to eliminate wasted product
- Pre-emergent, ice melt, grass seed and more



| SKU   | Description               |
|-------|---------------------------|
| 17002 | EarthShaker hand spreader |

# Electrical





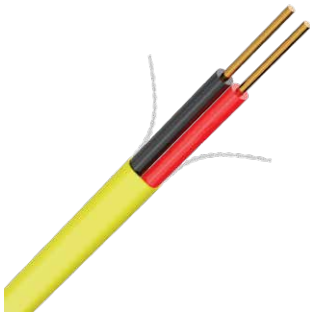

## Parallel Communication Cable

Regency's parallel communication cable is manufactured for the power and control of irrigation. It is direct burial rated.

Constructed in accordance with Underwriters Laboratories Inc with tin-coated, soft-drawn bare copper conductor construction that meets the requirements of ASTM specification B-3.

### FEATURES

- Two conductors insulated with a high-quality polyvinylchloride (PVC) for system applications up to 600 volts
- One black, one red insulated conductor
- Same-size conductors as specified and/or shown on drawings as required for proper operation of satellite and decoder units connected
- \*Conductors are laid parallel and pressure extruded with a solid color, low linear density, sunlight-resistant polyethylene (HDPE) outer jacket that comes in variety of colors for easy identification
- Dual rip cords for easy stripping

| SKU    | Description                  |
|--------|------------------------------|
| R7072D | Parallel Communication Cable |



## Ground Rod Plate

Regency's grounding plates are manufactured for the purpose of grounding applications as an alternative to ground rods.

Cut to size from sheets of copper alloy 110, the plate's ground wire is connected with a weld joint.

### FEATURES

- Soft-drawn insulated 6 AWG copper grounding wire construction meets the requirements of ASTM specification B-3

| SKU         | Description      |
|-------------|------------------|
| GRPL4X36-25 | Ground rod plate |



## Erico Cadweld

This exothermic weld is made from a single-use ceramic mold, eliminating the need for a graphite mold and handle clamp/frame. It produces a permanent connection that will not loosen or corrode.

### FEATURES

- Fits plain copper-bonded, threaded copper-bonded, full-size galvanized and stainless-steel ground rods
- NEC compliant

| SKU      | Description             |
|----------|-------------------------|
| CGT1161G | Single-use ceramic mold |



## 3M DBR/Y-6

Premium splice designed to connect and moisture seal an electrical connection for direct-bury applications. Moisture-resistant grease acts as a barrier for damp environments, reducing exposure to the elements in outdoor boxes and underground connections. Common uses: golf course irrigation, landscape lighting, direct bury.

### FEATURES

- Excellent for water-intensive applications such as golf courses, irrigation controls and outdoor lighting
- Contains 3M™ spring connector with different sizes depending on varying wire gauges
- UL listed for direct bury and rated for 600 volts

| SKU         | Description            |
|-------------|------------------------|
| 3MDBRY6-KIT | Direct bury splice kit |



## Paige Electric Golf & Landscape

### Irrigation Systems

Paige Electric is dedicated to the golf market, providing virtually any accessory required, including wire, waterproof connectors, earth-grounding products and more. Let our knowledgeable staff handle your product requirements and technical needs.

## Decoder & 2-Wire Cables, Direct Burial



| SKU      | Description                                     |
|----------|-------------------------------------------------|
| 180116C  | Rain Bird, 14/2c & 12/2c MAXI, P7072D           |
| 170801BU | Hunter 14/2c & 12/2c twisted & jacketed, P7354D |
| 170800   | Toro, 14/2c & 12/2c twisted & jacketed, P7350D  |



## Communication Cables, Direct Burial

| SKU      | Description                            |
|----------|----------------------------------------|
| 180095TH | 16/1pr Toro unarmored Tuf-hide® P7162D |
| 180008   | 18/2pr, unarmored, P7171D              |

## Earth Grounding Materials



| SKU      | Description                     |
|----------|---------------------------------|
| 182199IC | Ground plate w/ground wire      |
| 1820058  | Powerset earth contact backfill |

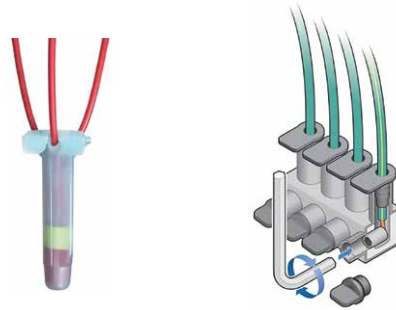

## Waterproof Connectors

| SKU    | Description                      |
|--------|----------------------------------|
| 270672 | 3M DBR/Y-6 waterproof connectors |
| 270320 | 3M #3570G-N epoxy packs          |
| 270RCX | Re-enterable connectors          |

**The Best Conditions Require the Best Partners.**  
**LEAN ON US!!!**

Scan the QR Code and let us know how we can help you.





## Pro2TK™

The Armada Technologies Pro2TK™ two-wire tool kit consists of everything necessary to test two-wire irrigation systems, all stored in one place.

The ProCase™ is a professional looking carrying case that is easy to bring with you on the job and holds all the essentials. The mesh section can hold wipes, wire nuts, cords, etc.



### Pro2TK™ kit includes:

- Pro50™ digital tester and 24-volt power source
- Pro95i™ milliamp clamp multimeter
- Pro210F™ tone probe
- Pro55™ stainless-steel wire strippers
- Scrubbuz™ silicone sealant gel removing wipes
- User guides

### FEATURES

- Hard-shell plastic case with steel hinges
- Firm foam insert custom fit for testers and strippers
- Mesh pouch for cords and smaller accessories
- Replaceable latches

| SKU    | Description                |
|--------|----------------------------|
| Pro2TK | Two-wire tool kit and case |



## Pro50™/50K™

The digital capability of the Pro50™ allows it to test AC, DC, high resistance and any low-voltage solenoid out there. The Pro50™ can do them all with the digital LCD screen, unlike the old analog models. Some DC solenoids read less than 20 ohms and will be diagnosed as shorts. On the Pro50™, a 4-ohm solenoid reads as 4 ohms, thereby correctly identifying it as a good-working solenoid. Digital is smarter. In addition to digital features, the Pro50™ also sends a tracing tone for wire identification. The Pro50™ uses four AA batteries for longer life. For long-term affordability, the Pro50™ features 24" detachable alligator leads (cords) so if they deteriorate, they are easily replaceable.

| SKU    | Description                                          |
|--------|------------------------------------------------------|
| Pro50  | Advanced digital multifunction irrigation tester     |
| Pro50K | Advanced digital multifunction irrigation tester kit |



## Pro48™/48K™

The Pro48™ tests clock voltage output, solenoid and wire condition, solenoid operation as well as wire toning. The Pro48™ uses an easy-to-follow LED system that walks a user through the process. The Pro48™ also chatters solenoids – useful for locating lost or covered valve boxes. Simple to operate, the Pro48™ uses two nine-volt batteries for all the power needed to operate solenoids. The Pro48™ multifunction irrigation system tester is a value-priced tester for irrigation contractors and maintenance personnel. The available Pro48K™ adds a tone probe and a zippered carrying case.

### FEATURES

- Activates and holds solenoids open (including DC latching)
- Generates and traces 1Khz tracing tone
- Check's clock 24-vole power output
- Tests for open or shorted wiring
- Uses 2 nine-volt batteries (not included)

| SKU    | Description                        |
|--------|------------------------------------|
| Pro48  | Solenoid activator/chatterer       |
| Pro48K | Pro48 kit w/case and Pro210F probe |

## Pro65™

The Armada Technologies model Pro65™ plastic pipe-tracing accessory (or snake) is a simple yet effective tool for tracing an underground pipe or conduit that does not have an accompanying trace wire. The Pro65™ is the world's smallest tracer, able to navigate 90-degree bend radiuses of just under two inches. This means that some of the smallest PVC or plastic pipes can now be traced without digging or cutting the pipe. In the sprinkler world, simply remove the sprinkler head, insert the Pro65™ into the pipe and apply pressure to move it along the path. 1¼" pipe is no problem. At the end of the Pro65™ is a sonde, which acts as a beacon and sound spot when used with a 33kHz transmitting locator. The Pro65™ works with any locator to track path but the sonde tip requires 33kHz for the extra sound boost.



### SPECIFICATIONS

- Working frequency: 33 kHz
- Path detection depth: 5'
- Tip detection depth: 7'
- Sonde detection depth: 7'
- Rod length: 65'
- Rod diameter: 0.2"
- Minimum bend radius: 2.0"
- Reel dimensions: 4.7" (W) x 5.9" (L) x 9.8" (H)
- Reel weight: 2.75 lb
- Operating temperature: -4°F to 122°F
- Water and dust rating: IP65

| SKU   | Description                                          |
|-------|------------------------------------------------------|
| Pro65 | Plastic pipe-tracing rod with sonde (33 kHz), 65 ft. |



## Pro95i™

The Pro95i™ advanced AC milliamp clamp multimeter is perfect for two-wire troubleshooting. The Pro95i™ makes it possible to diagnose cable and equipment faults in two-wire systems without opening splices. The Pro95i™ measures AC line current with a resolution of one microampere simply by clamping over wires in a control cable. In addition, VAC, VDC and ohms measurements are available. All utilize a built-in auto ranging function for easy use.



### FEATURES

- Contactless measurement of line currents down to 5 microamperes – a critical and necessary feature in diagnosing 2-wire faults
- True RMS measurement with automatic signal smoothing for improved accuracy
- Auto-off after 30 minutes idle
- Backlit screen for dark areas

### SPECIFICATIONS

**Current:** Range from five microamperes to 60 amperes AC; resolution to 1 microampere

**Voltage:** VAC to 600V, VDC to 600V

| SKU    | Description                   |
|--------|-------------------------------|
| Pro95i | Advanced milliamp clamp meter |

## Pro400™

The Pro400™ is a professional time domain reflectometer and toner designed to detect and locate faults on copper cables up to a distance of 2,000 m (6,500 ft). Advanced signal processing techniques enable the Pro400™ to find opens, short circuits, splices, taps, water ingress and other more elusive impedance mismatches. A built-in tone generator also provides a tone for wire tracing and identification. Selectable cable impedance matching, along with variable velocity factor, enable the Pro400™ to be used to test all communication cables, including twisted pair and coaxial, with graphical results and fault distances displayed on a dot matrix LCD. The TDR/toner is housed in a tough, ruggedized ABS plastic molding, water and dust proof to IP54, and supplied complete with test leads and a protective tool-belt holster. The Pro400™ is designed and manufactured to international standards for quality, safety and reliability.



### SPECIFICATIONS

**Ranges:** @ Vp=70% 7, 15, 30, 60, 120, 250, 500m, 1km, 2km  
**Power supply:** 6V 4 x AA cells 23, 49, 98, 197, 394, 820, 1,640, 3,280, 6,560 ft.

**Auto power down:** Selectable 1,2,3 min. or disabled

**Range selection:** Manual range control

**Operating temperature:** 0° to 40° deg. C

**Resolution:** Approximately 1% of range

| SKU    | Description   |
|--------|---------------|
| Pro400 | Graphical TDR |

## Pro700 Duo™

The Pro700 Duo™ wire and valve locator improves on the popular Pro700™ model with the addition of continuous tone as well as the traditional pulsing tone. Simply choose pulse or continuous on the transmitter to change between the traditional pulsing tone and the new continuous/solid tone. The continuous tone is especially helpful in troubleshooting broken or severely damaged wires. Like the Pro700™ before it, the Pro700 Duo™ can be used to track wires, find lost irrigation valves and detect breaks in the wire path. It emits a powerful signal that is easily tracked using the receiver. The Pro700 Duo™ has five power output levels to adapt to any job, large analog meters that are easy to read and battery check buttons that quickly indicate the battery condition of the wand or transmitter.



### FEATURES

- Receiver has speaker, headset or visual indicators
- Pistol-style receiver is extended for ease of locating
- Increased receiver AC filtration
- Simple battery check of transmitter and receiver
- Custom rugged, slim carrying case
- Extra-long metal wand
- Two transmitter tone options of pulse or continuous

### SPECIFICATIONS

**Power requirements:** Transmitter - 8 D cell alkaline batteries (not included), receiver - 9V alkaline battery (not included)

**Battery life:** Transmitter - 50 hours, receiver - 50 hours

**Transmitter frequency:** 1748Hz transmitter

**Power:** 750V p-p, 285V rms

| SKU        | Description            |
|------------|------------------------|
| Pro700 Duo | Wire and valve locator |

## Pro800D™

With the Pro800D™, Armada Technologies has revolutionized the way we track and trace underground sprinkler wires and lost solenoids. With a combination of high performance and affordability, the Pro800D™, along with its predecessor, the Pro800™, has dominated the irrigation blogs, message boards and distributor counters because it can do what no other wire and valve locator can do.



### SPECIFICATIONS

**Power output:** 900V P-P

**Transmitter battery:** 8 D cell alkaline

**Receiver battery:** 1 9V square (included)

**Distance:** Up to 4,000'

**Depth:** Up to 8'

**Weight:** 8 lb (entire contents)

**Warranty:** 12 months from date of purchase

| SKU     | Description                                    |
|---------|------------------------------------------------|
| Pro800D | High-power wire and valve locator, D batteries |



## Pro881™

### New Product

The Pro 881™ underground cable locator is an easy, fast-operating digital locator designed to get the job done quickly and accurately. Minimal settings make the Pro881™ a great choice for a new or seasoned maintenance staff. Incorporating three different locating frequencies, the Pro881™ tracks many types of cabling, including irrigation, CATV, electrical, telephone and lighting. The Pro881™ incorporates digital reception filtration to eliminate unwanted AC noise and interference for efficient, uncomplicated locates.

The Pro881™ uses the IC4 inductive clamp, injecting a 175 kHz tracing signal onto energized or de-energized cabling while the digital filters remove signals that are not desired. Inductive locating allows non-contact connection of tracing signal, avoiding dangerous electrical voltages or disconnection of a traced cable.

### FEATURES

- Two direct and two indirect transmission methods
- Selectable null or peak reception for pinpointing
- Stereo headset included
- Low battery indicator
- Slim, custom-molded steel spine case

### SPECIFICATIONS

Depth: Up to 8'

Distance: 5,000' with direct connection

Distance: Unlimited with broadcast mode and leapfrogging

| SKU    | Description               |
|--------|---------------------------|
| Pro881 | Underground cable locator |

## Pro900™

For over 13 years, Armada Technologies has been developing and fielding electronic underground locators. These products have represented continuous improvement in the capability and value for users in a variety of industries. The Pro900™ is the latest in that line with features that make it useful in many fields: irrigation, outdoor lighting, cable services, telephone, facility maintenance and others. The availability of two connectionless tracking modes means simpler, safer tracing of buried wires and pipes, and the use of two selectable direct tracking frequencies makes the Pro900™ suitable for a wide range of wire depths and distances.

### SPECIFICATIONS

Tracking range depth: 8'

Distance: 5,000' with direct connection

Distance: Unlimited with broadcast mode and leapfrogging

| SKU    | Description                          |
|--------|--------------------------------------|
| Pro900 | Advanced digital underground locator |



## GFL3000™

The GFL3000™ ground fault locator is an essential tool for pinpointing insulation faults in direct buried cabling. Incorporating dual-power output, the GFL3000™ pinpoints ground faults where electrical voltage is being lost to ground. The GFL3000™ transmits a powerful charge that is tracked by the GFL3000™ receiver. By simply going in the direction of the analog needle kicks on the receiver, the exact spot of the fault can be found. Simply connect the transmitter to ground and the wire to be analyzed and turn it on. Follow the kicks with the receiver using the visual meter. The GFL3000™ features both high- and low-power capability and a simple reading on the battery power available.

### SPECIFICATIONS

Power requirements: 12 VDC

Battery type: 12V rechargeable (included), 9V NEDA (not included)

Power output: 2400 or 3400 VDC selectable

Voltage protection: 240VAC/400VDC

Weight: Transmitter - 9 lb with battery, A-frame - 3 lb

| SKU     | Description          |
|---------|----------------------|
| GFL3000 | Ground fault locator |



## Scrubbuzz™

Scrubbuzz™ is designed to remove some of the toughest messes of gel and goo faced by contractors. Waterproof wire nuts and caps get messy. Hands, tools and clothing get coated with a sticky material that won't come off easily with simple wipes. Scrubbuzz's combination of dual coarse sides gives it more cleaning power than the average wipes. One side provides optimal scrubbing power with teeth to grab onto any rough stains. The other side finishes your clean with a smooth and soft polish. Greasy messes stand no chance against the gel remover-infused Scrubbuzz™ with its extra strong material and cleaning formulation.

### FEATURES:

- Quickly removes silicone gunk
- Special dual-texture cloth surface
- Supersize with 2x ordinary wiping area
- Stays moist longer – over an hour of working time
- Safe for your hands
- Resealable pack of 20

| SKU       | Description                         |
|-----------|-------------------------------------|
| Scrubbuzz | Silicone sealant gel remover sheets |



# Accessories and Tools





## Custom Tee Markers

Wittek Golf's custom tee markers are expertly crafted, personalized golf accessories that add a touch of elegance to any golf course. These markers are designed with precision and attention to detail, allowing golf courses to showcase their unique brand identity and create a memorable experience for players. Made with high-quality materials, these custom tee markers are a perfect blend of functionality and style, enhancing the overall aesthetic of the course while providing golfers with clear and attractive tee box information.

### FEATURES

- Laminate tee markers
- Molded tee markers
- Bronze and aluminum tee markers
- Log-style tee markers
- Ball tee markers

#### Description

Contact your Ewing rep to custom order



## Custom Flags

Our flags are cut and sewn right here in the US. Do you need your logo on a flag to fly it high outside your business? Is there an event coming up that you need to promote? Are you a golf course that needs a set of 18 flags? Call us today for expert-level service.

### FEATURES

- Screen print flags
- Embroidery flags
- Dye sublimation flags
- Numbered flags
- Checkered flags

#### Description

Contact your Ewing rep to custom order



## Custom Signage

Our sign department has many years of experience in designing and manufacturing many different types of golf course and clubhouse signage. All work is done in-house with our focus on long-lasting, low-maintenance signs that will look great for years. Our design and manufacturing team can make it happen no matter what type of message you need to convey – from large entryway signs to small directional signs.

#### Description

Contact your Ewing rep to custom order

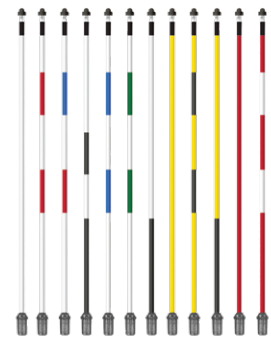

## Cups & Flagsticks

Wittek Golf's greens cups and flagsticks are the epitome of quality and durability in the golf industry. Crafted with precision and attention to detail, these essential course components ensure a smooth and reliable putting experience. Our cups are engineered to last, featuring top-notch materials and construction for years of play. Paired with flagsticks that are both sturdy and visually appealing, they provide the perfect finishing touch to any golf course, elevating the overall experience for players while maintaining the course's pristine aesthetics.

#### SKU Description

|        |             |
|--------|-------------|
| 400108 | Greens cups |
| 400415 | Flagsticks  |



## Rakes & Levelawn

Great tools to “level your lawn,” these instruments are trusted by professional grass growers and used by golf course superintendents worldwide. These tools smooth out soil for easy planting, distribute application materials evenly and blend elevations.

| SKU    | Description |
|--------|-------------|
| 401000 | Rake        |
| 29320  | Levelawn    |



## Rope & Rope Stakes

Every course is unique, which is why we provide a range of stakes, ropes and traffic diverters to enhance the appearance of any course. Our products are crafted in-house, proudly made in the USA and constructed from recycled plastic lumber for eco-friendly quality.

**Description**

Multiple colors and styles available. Contact your Ewing rep to custom order.

**THE BEST  
CONDITIONS  
REQUIRE  
THE BEST  
PARTNERS.  
LEAN ON US**

[EwingOutdoorSupply.com](http://EwingOutdoorSupply.com)



## Spring Brace Rake

24"/24 tines

### FEATURES

- A-shaped head combines flexible tines with durability of metal
- Bolt-thru head to handle connection
- Stress distribution bar prevents the 24 tines from twisting or breaking
- Tines and spring are made of high carbon steel
- Powder-coated frame and tines resist rust
- Available with 54" long aluminum or wood handle
- Lifetime warranty

### SPECIFICATIONS

67" x 23.75" x 2.25"

| SKU      | Description                                        |
|----------|----------------------------------------------------|
| RK 24061 | Spring brace rake - 24"/24 tines - aluminum handle |
| RK 24003 | Spring brace rake - 24"/24 tines - wood handle     |



## Fixed Tine Shrub Rake

8"/11 tines

### FEATURES

- Tempered spring steel for greater durability and long service life
- Bi-curved bow gives even pressure to all tines for maximum raking efficiency
- Tines apply light pressure for debris removal without damage to plant feeder roots
- Narrow head for working between closely spaced plants
- Two rivets hold head to handle
- Lifetime warranty

### SPECIFICATIONS

61" x 7.5" x 2"

| SKU      | Description                         |
|----------|-------------------------------------|
| RK 62000 | Fixed tine shrub rake - 8"/11 tines |



## BigLOAD™ Leaf Rake

30"/30 tines

### FEATURES

- Rake up to two times faster than standard leaf rakes
- Unique head design maximizes load capacity
- 30" wide poly head is both lightweight and durable
- 60" aluminum handle with anti-slip vinyl grip for gripping comfort in extreme heat or cold
- 18" long teeth for extra versatility
- Lifetime warranty

### SPECIFICATIONS

77" X 30.25" X 1.25"

| SKU      | Description                       |
|----------|-----------------------------------|
| RK 45030 | BigLOAD™ leaf rake - 30"/30 tines |



## Bow Head Rake

14"/14 Tines

### FEATURES

- Tempered, single-piece head for greater durability and long service life
- Curved tines efficiently gather and move soil
- Bow serves as spring for better control of tine depth
- 60" long northern ash wood handle allows working in upright position, reduces back strain
- Lifetime warranty

### SPECIFICATIONS

65.5" x 13.87" X 3"

| SKU      | Description                  |
|----------|------------------------------|
| RK 65001 | Bow head rake - 14"/14 tines |



## Aluminum Landscape Rake

24"/24 tines

### FEATURES

- All-aluminum construction combines durability with ease of use during finish grading process
- Angled, extra-thick tine tips for long service life
- 66" lightweight aluminum handles with non-slip vinyl sleeves for gripping comfort in extreme heat or cold
- Wrap-around brace supports and heavy-duty heads
- Assembly required
- Limited lifetime warranty

### SPECIFICATIONS

67" x 23.25" x 5.25"

| SKU      | Description                            |
|----------|----------------------------------------|
| RK 61061 | Aluminum landscape rake - 24"/24 tines |



## Bow Head Rake

14"/14 tines

### FEATURES

- 14" bow-head design acts as spring for better control of tine depth, small head is ideal for working in close quarters
- Extra-thick, tempered steel tines for greater strength and long life
- Curved tines efficiently gather and move soil
- 60" aluminum, oval-shaped handle with vinyl coating is lightweight and shaped for maximum strength
- Lifetime warranty

### SPECIFICATIONS

65.5" X 14.8" X 3"

| SKU      | Description                  |
|----------|------------------------------|
| RK 65061 | Bow head rake - 14"/14 tines |

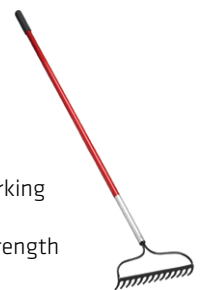



## #2 Square Point Shovel

### FEATURES

- 48" long northern ash wood handle
- Square-head design for efficient lifting and moving of loose material
- Large, forward-turned steps prevent material from spilling off rear of blade
- Extra-thick, 14-gauge tempered steel blade for maximum toughness
- Extended widow's peak socket adds strength for a secure connection
- Baked finish protects against rust
- Lifetime warranty

### SPECIFICATIONS

9.75" x 59.75" x 12"

| SKU      | Description                                       |
|----------|---------------------------------------------------|
| SS 66000 | #2 square point shovel - northern ash wood handle |



## Poly Wheelbarrow

10 cu ft

### FEATURES

- Heavy-duty, corrosion-proof poly tray with UV protection
- Reinforced steel-front tray braces for added support and stability
- 16" dual-wheel assembly with knobby, four-ply tires provide added control and stability when carrying heavy loads
- Ball bearings for years of smooth performance
- 60" hardwood handles
- Lifetime warranty

### SPECIFICATIONS

29.5" x 28.5" x 60"

| SKU     | Description                 |
|---------|-----------------------------|
| WB 1010 | Poly wheelbarrow - 10 cu ft |



## #2 Square Point Shovel

### FEATURES

- 48" solid-core fiberglass handle with thick, molded poly jacket for maximum strength and long service life
- Square-head design for efficient lifting and moving of loose material
- Large, forward-turned steps prevent material from spilling off rear of blade
- Extra-thick, 14-gauge tempered steel blade for maximum toughness
- Extended widow's peak socket adds strength for a secure connection
- Baked finish protects against rust
- Lifetime warranty

### SPECIFICATIONS

9" x 58.75" x 12"

| SKU      | Description                                           |
|----------|-------------------------------------------------------|
| SS 66020 | #2 square point shovel - solid-core fiberglass handle |



## Ewing 6 cu. ft. Wheelbarrow

Green Ewing 6 cu. ft. capacity wheelbarrow with all-steel frame, tray and handles. 16" flat-free knobby tires with solid steel bushing and grease fittings keeps projects moving forward.

| SKU      | Description                 |
|----------|-----------------------------|
| 28002800 | Ewing 6 cu. ft. wheelbarrow |





## Commercial 10" Telescopic Pole Saw

**Maximize uptime and grow your business with the powerful tools and smart tech of EGO Commercial.**

The EGO Commercial 10" telescopic pole saw is up to 40% lighter than leading pole saws and features a strong and light telescopic carbon fiber shaft. Powered by industry-leading 56 V ARC Lithium™ battery technology, the pole saw boasts a robust 1,200 W high-performance brushless motor that delivers instant torque for all-day power equivalent to a 25 cc gas engine with 20 m/s chain speeds. Designed for heavy-duty professional use, the pole saw's commercial-grade construction delivers five times longer life with precision-engineered UV-resistant composite housing and IPX5-rated weather resistance for working through the worst weather conditions. With its included extension pole, the saw extends to 12.5 feet for a total reach up to 17 feet for trimming, pruning and limbing operations. Your investment is protected with a two-year, no-catch warranty.

| SKU     | Description                        |
|---------|------------------------------------|
| PSX2510 | Commercial 10" telescopic pole saw |

## Commercial 17.5" String Trimmer

**Maximize uptime and grow your business with the powerful tools and smart tech of EGO Commercial.**

Powered by industry-leading 56 V ARC Lithium™ battery technology, the EGO Commercial 17.5" string trimmer boasts a robust 1,600 W high-performance brushless motor that delivers instant torque for all-day power equivalent to a 35 cc gas engine. Designed for heavy-duty professional use, the string trimmer's commercial-grade construction delivers five times longer life with precision-engineered UV-resistant composite housing and IPX5-rated weather resistance for working through the worst weather conditions. Its industrial-strength carbon fiber shaft stands up to job after job while being lightweight for easy handling along fence lines or around ground obstacles and garden beds. Three-speed digital control optimizes runtime at lower speeds or taps into maximum power to rip through dense grass and thick weeds. The ergonomic quick-adjust auxiliary handle allows fast transitions from trimming to edging with ultimate control. Work quickly and efficiently with the trimmer's large 17.5" cutting swath. Its Rapid Reload head accepts up to 26 feet of 0.095" to 0.120" professional-grade line and gets you back to work in seconds by lining up the arrows on the head, inserting the line and twisting. Your investment is protected with a two-year, no-catch warranty.



| SKU     | Description                     |
|---------|---------------------------------|
| STX4500 | Commercial 17.5" string trimmer |

## Commercial 800 CFM Backpack Blower

**EGO Commercial is setting the new standard in power, performance, and durability – and it's no longer driven by gas.**

The next-generation EGO Commercial 800 CFM backpack blower delivers 800 CFM, air speeds up to 190 mph and 26 N push force to power through the day. This battery-powered backpack blower features a high-performance 1,900 W brushless motor with intelligent electronics to deliver power equivalent to a 60 cc gas engine. Tailor performance with digital controls including a battery level indicator and speed control with turbo lock on the blower's fully adjustable hand grip and tube. Its commercial-grade construction is built for five times longer life with UV-resistant composite housing and IPX5-rated weather resistance for all-day professional use in the toughest conditions. The Commercial 800 CFM backpack blower runs up to 120 minutes on low, 30 minutes on high and 25 minutes on turbo with two included 56 V 6.0 Ah ARC Lithium™ batteries. Maximize uptime and productivity with minimal start-up tasks and less routine maintenance compared to gas blowers.



| SKU        | Description                        |
|------------|------------------------------------|
| LBPX8006-2 | Commercial 800 CFM backpack blower |

## POWER+ 20" Chain Saw

The EGO POWER+ 20" chain saw delivers the power and performance of a 55cc gas chainsaw without the noise, fuss or fumes. Powered by any EGO POWER+ 56 V ARC Lithium™ battery, this cordless chainsaw delivers up to 230 cuts on a 4 x 4 when used with the included 6.0 Ah ARC Lithium™ battery. Use the digital display for speed select modes and to check battery charge status.



| SKU     | Description          |
|---------|----------------------|
| CXX5000 | POWER+ 20" chain saw |

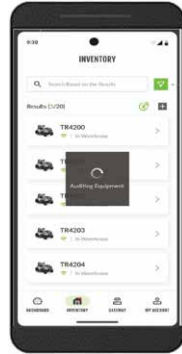

## EGO Fleet

EGO Fleet is our digital solution to maximize your teams' uptime. Manage the charging, usage and maintenance of your EGO Commercial equipment and batteries with total confidence. Includes web and mobile apps for power management, equipment management and business management.

### Description

EGO Fleet - Coming soon

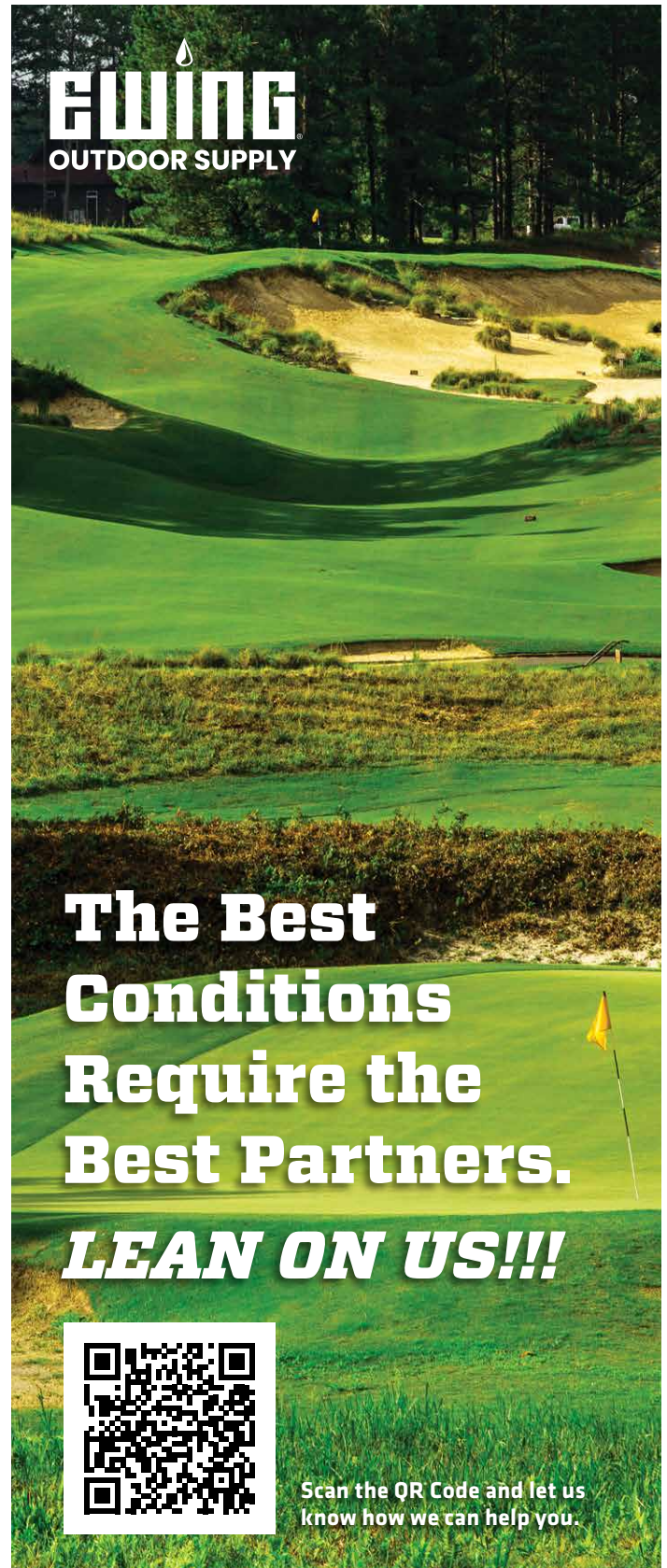

**The Best  
Conditions  
Require the  
Best Partners.  
LEAN ON US!!!**



Scan the QR Code and let us know how we can help you.

# Lake Management





## J Series Fountains

Kasco J Series fountains offer beautiful displays. Each package includes multiple twist-and-lock nozzles to choose from, including attention-demanding geysers to three-tier displays. Available as ¾, 1, 2, 3 or 5 hp, single- and three-phase, and in multiple cord lengths.

### FEATURES

- Lighting and premium nozzles available
- Two-year warranty on ¾ and 1 hp units
- Three-year warranty on 2 hp units (five-year warranty available)
- Five-year warranty on 3, 5, and 7.5 hp
- ETL listed to UL and CSA standards

| SKU       | Description                                               |
|-----------|-----------------------------------------------------------|
| 3400JF100 | J Series fountain, 100' cord, 3/4 hp, 120V, single phase  |
| 4400JF100 | J Series fountain, 100' cord, 1 hp, 120V, single phase    |
| 8400JF100 | J Series fountain 100' cord, 2 hp, 208-240V, single phase |
| 5.1JF100  | J Series fountain 100' cord, 5 hp, 208-240V, single phase |

## VFX Fountains

Kasco VFX Series fountains are the choice for an elegant display with superior aeration benefits. These high-flow units are efficient, easy to install, and can be used in countless settings. Available as ½, ¾, 1, 2 or 5hp, single- and three-phase, and in multiple cord lengths.

### FEATURES

- “V” shaped pattern
- Lighting packages available
- Two-year warranty on ¾ and 1 hp units
- Three-year warranty on 2 and 5 hp units (five-year warranty available)
- ETL listed to UL and CSA standards

| SKU        | Description                                                  |
|------------|--------------------------------------------------------------|
| 3400VFX100 | VFX Series fountain, 100' cord, 3/4 hp, 120V, single phase   |
| 4400VFX100 | VFX Series fountain, 100' cord, 1 hp, 120V, single phase     |
| 8400VFX100 | VFX Series fountain, 100' cord, 2 hp, 208-240V, single phase |
| 5.1VFX100  | VFX Series fountain, 100' cord, 5 hp, 208-240V, single phase |

## RobustAire™ Diffused Aeration

Restore your golf course pond's natural ecosystem by adding beneficial water movement. A continuous upward movement of water prevents unpleasant sights and smells and thoroughly mixes water to keep it healthy.

### FEATURES

- New cabinets stay cooler and cleaner
- No electricity in the water
- Clog-free, efficient diffuser
- Lifetime warranty - diffuser and cabinet
- 15-year warranty - tubing
- 3-year warranty - compressor

| SKU    | Description                                                                                |
|--------|--------------------------------------------------------------------------------------------|
| RA1-PM | RobustAire™ post mount cabinet, (1) ¼ hp compressor, 1 diffuser assembly, 100' ¾" tubing   |
| RA2-PM | RobustAire™ post mount cabinet, (1) ¼ hp compressor, 2 diffuser assemblies, 200' ¾" tubing |
| RA3-PM | RobustAire™ post mount cabinet, (1) ¼ hp compressor, 3 diffuser assemblies, 300' ¾" tubing |
| RA4    | RobustAire™ medium cabinet, (2) ½ hp 120V compressor, 4 diffuser assemblies                |
| RA5    | RobustAire™ medium cabinet, (2) ½ hp 120V compressor, 5 diffuser assemblies                |
| RA6    | RobustAire™ medium cabinet, (2) ½ hp 120V compressor, 6 diffuser assemblies                |

# Clubhouse





## Drip Zone Kit

Landscape Products' drip zone valve kit offers fast installation and durable performance for residential and small commercial properties and effluent water systems.

This pre-assembled unit includes a contamination-resistant VP-10 control valve with a metering design to keep the valve working and maintenance to a minimum, while the attached EZ Klean Y-filter with built-in regulator helps keep debris and excessive pressure in check.

### FEATURES

- Available in 1 x 3/4" and 1" sizes
- All-in-one kit for low-volume drip and micro spray irrigation zones
- VP-10 control valve with easy-operation internal bleed lever allows water to escape downstream during manual operation
- 150-mesh, stainless-steel filter
- Simple, one-piece molded diaphragm
- Removable handle prevents tampering after flow adjustment



| SKU               | Description                  |
|-------------------|------------------------------|
| 12000080          | 1 X 3/4" drip zone valve kit |
| 12000085          | 1" drip zone valve kit       |
| Replacement parts |                              |
| 12000389          | Stainless-steel screen       |
| 11030100          | Solenoid                     |
| 11030120          | Diaphragm                    |
| 11030130          | Cover                        |

## VP Series Valves

### Threaded plastic valve

Landscape Products' VP series plastic remote control valves are ideal for use in residential and commercial applications.

### FEATURES

- Reverse flow design
- Internal manual bleed
- Ideal for low-volume drip irrigation



| SKU      | Description                         |
|----------|-------------------------------------|
| 01000530 | VP-10 1" plastic electric valve     |
| 01000550 | VP-15 1 1/2" plastic electric valve |
| 01000560 | VP-20 2" plastic electric valve     |

## Y-Filters

An all-purpose filter with an improved cleaning plate and specially designed elongated slots. These maintain a cleaner screen by forcing the incoming dirty water to spread across a greater portion of the inside wall of the screen. The overall compact design of the filter allows for easier installation in minimal space.

### FEATURES

- 3/4" and 1" male IPS inlet and outlet options
- 3/4" MHT flush with cap
- Replacement stainless-steel screen

| SKU      | Description                                |
|----------|--------------------------------------------|
| 12000370 | 3/4" EZ Klean Y-filter                     |
| 12000374 | 1" EZ-Klean Y-filter                       |
| 12000389 | Replacement screen 150-mesh for 3/4" or 1" |



## EZ Klean Pressure-Regulating Y-Filters

Protect your drip micro-irrigation system from debris and maintain optimal pressure with Landscape Products' EZ Klean pressure-regulating Y-filters. The one-piece filter/regulator unit eliminates the expense of extra fittings and allows for easier installation in tight spaces.

### FEATURES

- 3/4" (25 psi) and 1" (30 psi) units
- 3/4" MHT flush with cap
- Made in the USA

| SKU      | Description                                |
|----------|--------------------------------------------|
| 12000372 | 3/4" EZ Klean pressure regulating Y-filter |
| 12000376 | 1" EZ Klean pressure regulating Y-filter   |
| 12000389 | Replacement stainless-steel screen         |



## Quick Coupling Valves

A wide range of quick coupler solutions for both potable and recycled water applications.

Landscape Products' quick coupling valves are specifically designed for any irrigation project that requires in-ground durability, quick water access and resistance to vandalism.

### FEATURES

- Engineered and manufactured for years of reliable daily use
- Water district compliant to meet all requirements for district standards
- Spring-loaded covers protect the quick coupling valve's components and ensure closing



| SKU      | Description                            |
|----------|----------------------------------------|
| 01005310 | LP 3RC-07 ¾" QCV - 1 piece             |
| 01005320 | LP 5RC-10 1" QCV - 1 piece             |
| 01005322 | LP 5LRCNP-1 1" QCV - 1 piece purple    |
| 01005410 | LP 33DRC-07 ¾" QCV - 2 piece           |
| 01005425 | LP 33DLRCNP-07 ¾" QCV - 2 piece purple |
| 01005430 | LP 44RC-10 1" QCV - 2 piece            |
| 01005440 | LP 44LRC-10 1" LC QCV - 2 piece        |
| 01005447 | LP 44LRCNP-10 1" QCV - 2 piece purple  |
| 01005460 | LP 33DK -07 ¾" QCV key                 |
| 01005470 | LP 44K-10 1" QCV key                   |
| 01005480 | LP 55K-10 1" QCV key                   |
| 01005520 | LP HS-075/20 hose swivel               |
| 01005525 | LP HS-100/22 hose swivel               |
| 01005530 | LP HS-101/23 hose swivel               |

## Brass Ball Valves

Landscape Products' full port, brass ball valves are suitable for a full range of liquids and gases in residential and commercial applications. These ball valves have an adjustable stem packing gland that provides longer service life and are CSA approved.



### FEATURES

- Bottom-loaded blowout-proof stem
- PTFE stem packing seal and seats
- Machined chrome-plated brass ball

| SKU      | Description                     |
|----------|---------------------------------|
| 21013305 | ½" BBV-4 CSA & NSF brass valve  |
| 21013307 | ¾" BBV-4 CSA & NSF brass valve  |
| 21013310 | 1" BBV-4 CSA & NSF brass valve  |
| 21013312 | 1¼" BBV-4 CSA & NSF brass valve |
| 21013315 | 1½" BBV-4 CSA & NSF brass valve |
| 21013320 | 2" BBV-4 CSA & NSF brass valve  |
| 21013325 | 2½" BBV-4 CSA & NSF brass valve |
| 21013330 | 3" BBV-4 CSA & NSF brass valve  |

## Brass Gate Valves

Landscape Products' brass gate valves can be used in water, oil or compressed gas applications.

### FEATURES

- A 2" IPS brass gate valve with female threaded sockets on each end
- Brass body
- Non-rising stem
- Threaded bonnet



| SKU      | Description                       |
|----------|-----------------------------------|
| 21003105 | ½" BGV brass gate valve threaded  |
| 21003107 | ¾" BGV brass gate valve threaded  |
| 21003110 | 1" BGV brass gate valve threaded  |
| 21003112 | 1¼" BGV brass gate valve threaded |
| 21003115 | 1½" BGV brass gate valve threaded |
| 21003120 | 2" BGV brass gate valve threaded  |
| 21003125 | 2½" BGV brass gate valve threaded |
| 21003130 | 3" BGV brass gate valve threaded  |
| 21003140 | 4" BGV brass gate valve threaded  |

## CWV Ball Valves

Landscape Products' CWV ball valves offer a great combination of quality and affordability. These general-purpose cold water valves are made in the USA using premium-grade resins and are produced with the highest quality standard.



### FEATURES

- Quarter-turn shutoff valve designed for irrigation and other general cold water applications
- Available in slip socket and threaded models
- EPDM O-rings
- ASTM D 1784 cell classification 12454
- Made in the USA

| SKU      | Description                |
|----------|----------------------------|
| 20000105 | ½" slip socket ball valve  |
| 20000107 | ¾" slip socket ball valve  |
| 20000110 | 1" slip socket ball valve  |
| 20000112 | 1¼" slip socket ball valve |
| 20000115 | 1½" slip socket ball valve |
| 20000120 | 2" slip socket ball valve  |
| 20000205 | ½" threaded ball valve     |
| 20000207 | ¾" threaded ball valve     |
| 20000210 | 1" threaded ball valve     |
| 20000215 | 1½" threaded ball valve    |
| 20000220 | 2" threaded ball valve     |



## Valve Boxes

Landscape Products' valve boxes are engineered for the professional contractor, with the superior strength required for commercial and utility applications. They feature thicker wall dimensions for increased strength and durability, reinforced covers for heavier loads, reinforced ribs for sidewall strength and high-impact construction.

### FEATURES

- Overlapping covers prevent dirt and grass from settling between body and cover
- Reinforced covers for heavier loads
- 7" models available with green lid for turf installations, tan for decomposed granite applications and purple cover for use with non-potable or reclaimed applications
- 6" emitter box with deep opening that allows for multiple drip micro tubes
- Reinforced ribs for increased sidewall strength
- High-impact construction

| SKU      | Description                                     |
|----------|-------------------------------------------------|
| 12001690 | 6" round emitter box with black lid             |
| 12001695 | 6" round black emitter box lid only             |
| 38002610 | 6" round valve box with green lid               |
| 38002650 | 6" round green valve box lid only fits 38002610 |
| 38005610 | 7" round valve box with green lid               |
| 38005630 | 7" tan round valve box with tan lid             |
| 38005650 | 7" round valve box with purple lid              |
| 38005620 | 7" green valve box lid only fits 38005610       |
| 38005640 | 7" tan valve box lid only fits 38005630         |
| 38005710 | 10" round valve box with green lid              |
| 38005720 | 10" green valve box lid only fits 38005710      |
| 38005810 | Oval valve box with green lid                   |
| 38005820 | Oval green valve box lid only fits 38005810     |
| 38005830 | Oval valve box with tan lid                     |
| 38005840 | Oval tan valve box lid only fits 38005830       |



Visit our website for a complete listing of products, literature, specifications and resource documents for our drip micro irrigation products.



## PE & Vinyl Tubing

High-quality polyethylene (PE) tubing manufactured by Landscape Products is ideal for use in drip irrigation systems for landscapes and agriculture. This tubing can be used to connect any drip or micro device to the water supply lateral or to attach to the outlet of a buried emitter to bring water to the surface. It can also be used as a leader to bring water from a buried hose to a surface emitter or micro sprayer.

All PE tubing is made with 100% Dow Chemical 7510 material, which has a 30-plus year record of product quality. This material is known for having excellent environmental stress crack resistance (ESCR). A minimum of 2% carbon black color protects the tubing from the harmful effects of the sun.

| SKU      | Description                                  |
|----------|----------------------------------------------|
| 12000995 | LP 185 1/8" x 1,000' vinyl tubing            |
| 12000890 | LP 220 1/4" x 100' vinyl drip tubing         |
| 12000900 | LP 220 1/4" x 1,000' vinyl tubing            |
| 12000910 | LP 250 1/4" x 100' vinyl tubing              |
| 12000915 | LP 250 1/4" x 1,000' vinyl tubing            |
| 12000920 | 1/4" x 1,000' PE tubing                      |
| 12000925 | 1/4" x 1,000' PE tubing bucket refill        |
| 12000934 | 1/4" x 1,000' vinyl tubing in bucket         |
| 12000940 | LP 350 1 1/32" x 500' PE tubing              |
| 12001000 | LP 185 1/8" x 100' PE tubing                 |
| 12001005 | LP 185 1/8" x 1,000' PE tubing               |
| 12001006 | LP 250 1/4" x 100' PE tubing                 |
| 12001007 | LP 250 1/4" x 1,000' PE tubing               |
| 12001008 | LP 710 1/2" x 100' PE tubing                 |
| 12001010 | LP 710 1/2" x 500' red stripe drip tubing    |
| 12001012 | LP 710 1/2" x 500' white stripe drip tubing  |
| 12001014 | LP 710 1/2" x 500' purple stripe drip tubing |
| 12001016 | LP 710 1/2" x 500' no stripe drip tubing     |
| 12001018 | LP 940 3/4" x 100' PE tubing                 |
| 12001020 | LP 940 3/4" x 500' drip tubing               |
| 12001024 | LP 940 3/4" x 500' PE purple stripe tubing   |
| 12001026 | LP 940 3/4" x 500' black PE tubing           |
| 12001030 | LP 1200 1" x 500' PE drip tubing             |



## Point Source Emitters

Landscape Products' pressure-compensating (PC) emitters deliver a precise amount of water regardless of pressure changes within an operating range of 15–50 psi. This series of turbulent-flow, PC emitters with ¼" self-piercing barb are color coded based on flow rate desired. Available in 0.5 gph (blue), 1.0 gph (black), 2.0 gph (red) and 5.0 gph (tan) flow rates. The PC emitter flush mode allows for debris to be purged at start up.

### FEATURES

- Easy-install, self-piercing design
- PC emitter with ¼" outlet
- Color-coded flow rate matching the industry standard for easy recognition in the field
- PC emitter flush mode allows for debris to be purged at start up

| SKU      | Description                        |
|----------|------------------------------------|
| 12001511 | PC emitter 0.5 gph blue - 100/bag  |
| 12251511 | PC emitter 0.5 gph blue - 25/bag   |
| 12001512 | PC emitter 1.0 gph black - 100/bag |
| 12251512 | PC emitter 1.0 gph black - 25/bag  |
| 12001513 | PC emitter 2.0 gph red - 100/bag   |
| 12251513 | PC emitter 2.0 gph red - 25/bag    |
| 12001515 | PC emitter 5.0 gph tan - 100/bag   |
| 12251515 | PC emitter 5.0 gph tan - 25/bag    |

## EZ-ID CV Dripline

All EZ-ID CV dripline is made using 100% Dow Chemical 7510 polyethylene (PE) material, which has a 30-plus year record of product quality and has excellent environmental stress crack resistance. The UV-stabilized brown color protects the tubing from the harmful effects of the sun and blends well into the landscape. The dripline is color coded with double stripes for easy identification in the field. The 1.0 gph has white stripes, the 0.6 gph has blue stripes and the 0.4 gph has orange stripes.

### FEATURES

- Accepts standard 17 mm brown fittings
- Pre-installed internal emitters for simple installation
- Dual outlets at each emitter provide excellent clogging resistance
- Brown external color with excellent UV resistance
- Ideal for on-surface and sub-surface applications

| SKU      | Description                              |
|----------|------------------------------------------|
| 12050910 | 17 mm blank dripline tubing – 100'       |
| 12050920 | 17 mm blank dripline tubing – 250'       |
| 12075410 | 0.4 gph emitters 100' roll x 12" spacing |
| 12075430 | 0.4 gph emitters 500' roll x 12" spacing |
| 12075440 | 0.4 gph emitters 100' roll x 18" spacing |
| 12075460 | 0.4 gph emitters 500' roll x 18" spacing |
| 12075610 | 0.6 gph emitters 100' roll x 12" spacing |
| 12075620 | 0.6 gph emitters 250' roll x 12" spacing |
| 12075630 | 0.6 gph emitters 500' roll x 12" spacing |
| 12075640 | 0.6 gph emitters 100' roll x 18" spacing |
| 12075660 | 0.6 gph emitters 500' roll x 18" spacing |
| 12075910 | 1.0 gph emitters 100' roll x 12" spacing |
| 12075920 | 1.0 gph emitters 250' roll x 12" spacing |
| 12075930 | 1.0 gph emitters 500' roll x 12" spacing |
| 12075940 | 1.0 gph emitters 100' roll x 18" spacing |
| 12075960 | 1.0 gph emitters 500' roll x 18" spacing |

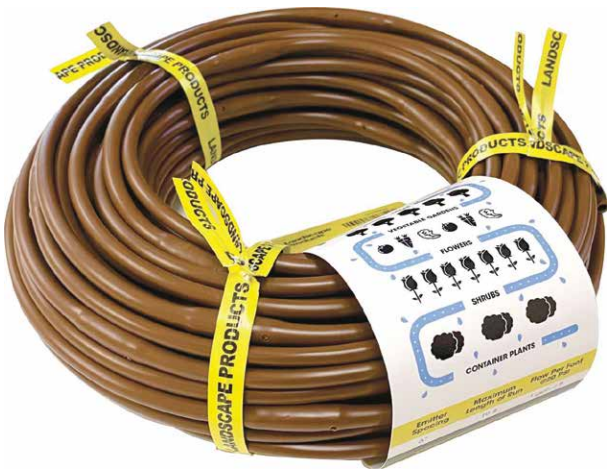

## 1/4" Dripline

Made with high-quality Dow Chemical virgin 7510 UV-resistant polyethylene to be the most durable in the industry. Landscape Products' 1/4" dripline is available with emitters at 6" or 12" spacing, making it ideal for residential and commercial applications. UV-stabilized brown coloring protects the tubing from the harmful effects of the sun and blends perfectly into the landscaping.

### FEATURES

- Ideal for use in drip irrigation systems for trees, vegetable gardens, flowers, shrub and groundcover beds
- Easy installation
- Water only where needed
- Feed from either end
- Blends into the landscape

| SKU      | Emitter Spacing | Coil Size | Max. Length of Run | Flow/Foot at 20 psi |
|----------|-----------------|-----------|--------------------|---------------------|
| 12070010 | Blank           | 100'      | N/A                | N/A                 |
| 12070110 | 6"              | 100'      | 19'                | 1.0 gph/ft          |
| 12070150 | 6"              | 500'      | 19'                | 1.0 gph/ft          |
| 12070210 | 12"             | 100'      | 33'                | 0.5 gph/ft          |
| 12070250 | 12"             | 500'      | 33'                | 0.5 gph/ft          |

All dripline above: I.D. - 0.17"; O.D. 0.25"; Wall - 0.04"; Max. operating psi - 30 psi



## Dripline Header Fittings

Landscape Products' 17 mm compression fittings are engineered and designed to create custom dripline headers. The installer can quickly and easily assemble headers to create straight or curved dripline layouts.



### FEATURES

- Connections are easy without glue or clamps
- Allows for custom spacing using either 1/2" (0.710) or 3/4" (0.930) polyethylene tubing
- 17 mm insert barb connectors allow for quick installation of EZ-ID CV dripline, as well as other 17 mm driplines.
- Made in the USA

| SKU      | Description                                   |
|----------|-----------------------------------------------|
| 12051110 | Dripline 17 mm insert coupling x 710C         |
| 12051120 | Dripline 17 mm insert x 710C 90° elbow        |
| 12051130 | Dripline 17 mm insert tee x 710C x 710C       |
| 12051170 | Dripline 17 mm insert x 930C 90° elbow        |
| 12051180 | Dripline 17 mm insert tee x 930C x 930C       |
| 12003212 | Dripline 17mm insert x 930C 3/4" male adapter |

## Dripline EZ-LOK Fittings



Landscape Products' EZ-LOK fittings are ideal for new installations and maintenance repairs on drip micro irrigation systems. They are suitable for dripline as well as polyethylene tubing sizes 16 to 18 mm.

### FEATURES

- Designed to be quick, secure, easy to install and reusable
- UV resistant to withstand heat, direct sun and harsh chemicals
- Heavy duty for added strength, durability and long-term performance
- Made in the USA

| SKU      | Description                        |
|----------|------------------------------------|
| 12050510 | EZ-LOK coupling 16-18 mm           |
| 12050520 | EZ-LOK 90° elbow 16-18 mm          |
| 12050530 | EZ-LOK tee 16-18 mm                |
| 12050535 | EZ-LOK 1/2" male adapter 16-18 mm  |
| 12050540 | EZ-LOK 3/4" male adapter 16-18 mm  |
| 12050570 | EZ-LOK hose end with cap 16-18 mm  |
| 12050580 | EZ-LOK female hose swivel 16-18 mm |
| 12050595 | EZ-LOK repair pak 16-18 mm         |



## Swing Riser Pipe

Landscape Products' 1/2" swing riser pipe is made from linear low-density polyethylene with added elastomers that make the product tough, resilient and flexible. This swing riser pipe is used with barbed fittings to attach sprinkler heads to buried laterals providing a flexible joint that helps prevent damage to the buried pipelines if the sprinkler is hit by maintenance equipment.

### FEATURES

- Performs best when used with Landscape Products' spiral barb fittings
- New textured surface for better grip
- Made in the USA

| SKU      | Description                        |
|----------|------------------------------------|
| 01004100 | 1/2" x 100' swing riser pipe       |
| 01004010 | 1/2" x 10' swing riser pipe bundle |

## Swing Riser Assemblies

Landscape Products' compression-style swing risers are made of 100% virgin material, pre-assembled and pressure tested for leak-free operation.

### FEATURES

#### Spiral barb fitting style

- Available in 6" and 12" lengths
- Reduced blow-off failure at high pressure over competitive products
- Assembly fittings may be adjusted to address specific applications at the installation site
- Available in various factory-assembled lengths and configurations

#### Compression fitting style

- Available in 7" and 13" lengths
- Zero pressure loss across the fittings because the ID of the fitting is larger than the ID of the pipe
- Easily field adjustable with only one contact point between the hose and fitting
- Available in various factory-assembled lengths and configurations

| SKU      | Description                                      |
|----------|--------------------------------------------------|
| 01001010 | Barbed single swing riser 1/2" x 1/2" x 6"       |
| 01001020 | Barbed double swing riser 1/2" x 1/2" x 6"       |
| 01001030 | Barbed single swing riser 1/2" x 1/2" x 12"      |
| 01001040 | Barbed single swing riser 1/2" x 3/4" x 12"      |
| 01001050 | Barbed double swing riser 1/2" x 1/2" x 12"      |
| 01001060 | Barbed double swing riser 1/2" x 3/4" x 12"      |
| 01001100 | Compression single swing riser 1/2" x 1/2" x 7"  |
| 01001102 | Compression single swing riser 1/2" x 3/4" x 7"  |
| 01001104 | Compression single swing riser 3/4" x 3/4" x 7"  |
| 01001105 | Compression single swing riser 1/2" x 1/2" x 13" |
| 01001107 | Compression single swing riser 1/2" x 3/4" x 13" |
| 01001108 | Compression single swing riser 3/4" x 3/4" x 13" |



## Slip Fix Repair Couplings

Landscape Products' slip fix repair couplings are ideal for quick and easy repairs on broken PVC irrigation lines. These slip fix couplings have an easy-grip body handle and patented internal rotational lock of spigot to body.



### FEATURES

- Available in ½" through 4" models – Note: Piston must be extended 1½ inches minimum
- Made of PVC Schedule 40 Type I material and molded in China
- Iron pipe size/IPS – same as Schedule 40
- Spigot – same as pipe outside diameter
- HUB – fits IPS pipe

### PRESSURE & OTHER RATINGS:

- Rated at 200 psi static pressure at 72°F
- All parts (except 03100130 & 03100140) are NSF/ANSI 61+372, PPC listed

| SKU      | Description                   |
|----------|-------------------------------|
| 03100105 | ½" slip fix repair couplings  |
| 03100105 | ¾" slip fix repair couplings  |
| 03100110 | 1" slip fix repair couplings  |
| 03100112 | 1¼" slip fix repair couplings |
| 03100115 | 1½" slip fix repair couplings |
| 03100120 | 2" slip fix repair couplings  |
| 03100130 | 3" slip fix repair couplings  |
| 03100140 | 4" slip fix repair couplings  |

## Grass-Cel Paving Blocks

Grass-Cel paving blocks are tough and resilient, and their honeycomb structure makes each piece strong and durable. Each honeycomb cell has a round opening at the base through which air, water and nutrients move to the soil below. Grass roots extend through these holes, binding the Grass-Cel Pavers to the surface. The longer this paving is down, the stronger the surface becomes. The slot provided in the walls of each cell allow roots, stolons and rhizomes to move freely from cell to cell. Soil within these cells cannot be compacted by normal use as traffic is supported by the vertical walls of the honeycomb structure.



### FEATURES

- Grass-Cel paving blocks transform your heavy traffic areas into beautiful lawns
- Prevent wear and compaction on intensive-use turfgrass areas
- Prevents soil compaction in high traffic areas
- Ideal for gravel or decomposed granite paving surfaces

| SKU      | Description                      |
|----------|----------------------------------|
| 24040020 | Grass-Cel pavers 13" x 12" x 1½" |

## Utility Hand Pump

This pump is used for removing water from valve boxes. It also functions as a general-purpose pump for several other uses in water transfer. This Landscape Products' hand pump is lightweight, non-sparking and doesn't need priming.



### FEATURES

- Height: 36"
- Made of high-impact PVC
- Removable foot for easy cleaning
- Steel shaft improves strength
- Outlet hose: 72" x 1¼"

*WARNING: California Proposition 65 non-compliant LPI Prop 65 Notice*

| SKU      | Description                                  |
|----------|----------------------------------------------|
| 26009010 | 6' water transfer utility hand pump          |
| 26009018 | Utility hand pump extension/replacement hose |

## Dryconn Waterproof Wire Connectors

The Dryconn DBR/Y-600 waterproof wire connector is UL listed and rated at 600 volts. The housing is UV- and impact-resistant and is excellent for aboveground or direct bury applications. This is a two-part system, including Gorilla Nuts™ Red cushion grip wire connectors and pre-filled silicone filled tubes.



This connector is perfect for low-voltage lighting, traditional irrigation and two-wire decoder system applications.

### FEATURES

- A waterproof wire connector ideal for low-voltage lighting or two-wire irrigation systems
- For use with solid and stranded wire
- 600-volt max and fits 22- 8-gauge wire
- This pack comes with two silicone-filled tubes and Gorilla Nuts™ red wire nuts
- Made in the USA with US and foreign parts

| SKU      | Description                                    |
|----------|------------------------------------------------|
| 17000280 | DBR/Y-600 waterproof wire connectors – 2 pack  |
| 17000282 | DBR/Y-600 waterproof wire connectors – 25 pack |



## Rice Straw Wattles



The Earthsavers® original Rice Straw Wattle is produced with noxious weed-free straw certified by the USDA. They have been performance tested at San Diego State University and have almost two decades of proven field performance, Earthsavers wattle is the wattle the industry asks for by name.

### FEATURES

- They come photodegradable or biodegradable
- Functional longevity of 18-24 months

### RECOMMENDED USES

- Perimeter protection: Straw Wattles act as a ponding device to keep sediment-laden water from leaving the site. Larger-diameter wattles are sometimes used when more sediment-holding capacity is required, often replacing silt fence. Straw wattles are also frequently used for inlet and stockpile protection applications.
- Slope interruption: Installed on slope contours, straw wattles act as a slope interrupter, effectively reducing the length of the slope. Temporary ponding behind wattles increases infiltration, reduces runoff and allows seed and sediment to drop out of suspension and create enhanced seed bed. Water is then released through the wattle at a slower, steady rate.
- Low-flow channels and swales: Installed across the flow in channel applications, wattles serve to decrease the energy gradient of the channel, trapping sediment upstream of the installation.

| SKU       | Description                                  |
|-----------|----------------------------------------------|
| 4000-4200 | 8.5" dia x 25' rice straw wattle - photo net |
| 4000-4300 | 8" dia x 25' rice straw wattle - burlap      |



## Sand and Gravel Bags



| SKU          | Description                                                      |
|--------------|------------------------------------------------------------------|
| 2700-1000    | 14"x26" sandbag burlap w/tie                                     |
| 2800-1050    | 14" x 26" sandbag w/tie - UV-stabilized - white (1000/bale)      |
| 2800-1051    | 14" x 26" sandbag w/tie - UV-stabilized - orange (1000/bale)     |
| 2800-1052    | 14" x 26" sandbag w/tie - UV-stabilized - green (1000/bale)      |
| 2800-1052-NT | 14" x 26" sandbag no tie - UV-stabilized - green (1000/bale)     |
| 2800-1053    | 14" x 26" sandbag w/tie - UV-stabilized - tan (1000/bale)        |
| 2800-1100    | 17" x 30" sandbag w/tie - white (1000/bale)                      |
| 3000-4000    | 19" x 28" gravel bag monofilament - orange (250/box)             |
| 3000-4000-Y  | 19" x 28" gravel bag monofilament - yellow (250/box)             |
| 3300-1000    | 17" x 28" gravel bag knit - dark green (100/box)                 |
| 3300-2000    | 17" x 5" x 26" knit w/zipper - sed. saver - dark green (100/box) |
| 3300-4100    | 18" x 30" nonwoven gravel bag 8 oz. - black (100/bundle)         |
| 3300-4105    | 18" x 30" nonwoven gravel bag filled 8 oz. - black               |

## Fencing



| SKU          | Description                                                            |
|--------------|------------------------------------------------------------------------|
| 7000-1000    | 4ft. x 100ft. barrier fence - 8 lbs. - orange (domestic)               |
| 7000-1000    | 4ft. x 100ft. barrier fence - 8 lbs. - orange                          |
| 7000-2500    | 4ft. x 100ft. barrier fence C-DOT - 12 lbs. - green (domestic)         |
| 7000-2505N   | 4ft. x 100ft. barrier fence C-DOT - 12 lbs. - orange                   |
| 7000-2515    | 4ft. x 100ft. barrier fence FHWA - 17 lbs. - orange                    |
| 7000-2520    | 4ft. x 100ft. barrier fence FHWA - 17 lbs. - dark green                |
| 7000-2522    | 4ft. x 100ft. barrier fence FHWA - 17 lbs. - black                     |
| 7000-2523    | 4ft. x 100ft. snow/safety fence - 19 lbs. - HiVis orange               |
| 7000-3999    | 4ft. x 100ft. gopher wire (hardware cloth) 1/2" x 1/2" 19ga HD galv.   |
| 7550-4030G   | 3ft. x 100ft. silt fence - 11 stake - 1.25" @ 10ft. OC - commercial    |
| 7550-4035G   | 3ft. x 100ft. silt fence - 11 stake - 1.5" @ 10ft. OC - C-DOT          |
| 7550-4100G   | 3ft. x 100ft. silt fence - 13 stake - 1.5" @ 8ft. OC - C-DOT           |
| 7550-4120G   | 3ft. x 100ft. silt fence - 17 stake - 1.5" @ 6ft. OC - C-DOT           |
| 7600-2010    | 36" x 100ft. silt fence - 24" wire 14ga - 2" x 4" opening              |
| 7600-2030-48 | 48" x 100ft. silt fence - 36" wire 14ga - 2" x 4" opening - C-DOT      |
| 7600-2251    | 3ft. x 500ft. silt fence fabric only - commercial                      |
| 7600-2252    | 3ft. x 500ft. silt fence fabric only - orange - commercial             |
| 7600-2300    | 3ft. x 500ft. silt fence fabric only - black - C-DOT                   |
| 7600-2320    | 3ft. x 500ft. silt fence fabric only - solid orange - C-DOT            |
| 7600-2350    | 3ft. x 1500ft. silt fence fabric only - 4" core - C-DOT                |
| 7600-2360    | 3ft. x 1500ft. silt fence fabric only - solid orange - 4" core - C-DOT |

## Coir Blanket



| SKU       | Description                           |
|-----------|---------------------------------------|
| 4000-4420 | 4M x 50M coir blanket 400 gram (bale) |
| 4000-4450 | 4M x 25M coir blanket 700 gram (bale) |
| 4000-4452 | 4M x 25M coir blanket 700 gram (roll) |
| 9300-4600 | 4M x 25M coir blanket 900 gram (bale) |

## Erosion Control

| SKU       | Description                                          |
|-----------|------------------------------------------------------|
| 9075-3200 | 16" 30mil greens inter 723 ft. - rigid water barrier |
| 9075-4200 | 18" 30mil greens inter 642 ft. - rigid water barrier |
| 9260-1358 | circle top pins 6" 500/ctn                           |
| 9260-1355 | 616 11ga sq staple (100 ea/bag - 1000 ea/box)        |

## Landscape Fabric

| SKU      | Description                           |
|----------|---------------------------------------|
| 24020320 | 4' X 300' polypun landscape fabric    |
| 24020340 | 6' X 300' polypun landscape fabric    |
| 24020515 | 3' X 250' 5 oz woven landscape fabric |
| 24020540 | 6' X 250' 5 oz woven landscape fabric |
| 24020420 | 4' X 300' 4 oz nonwoven filter fabric |
| 24020440 | 6' X 300' 4 oz nonwoven filter fabric |

Check with your local branch for additional sizes and fabric options

## Tree Ties

| SKU      | Description                      |
|----------|----------------------------------|
| 24066610 | 300' green tree-tie webbing      |
| 24063520 | Cinch-tie 24" tree ties          |
| 24063530 | Cinch-tie 32" tree ties          |
| 24067520 | Duckbill 68-DTS tree anchor kit  |
| 24067810 | Arborbrace tree guying kit 2"-4" |

## Stakes



| SKU       | Description                                                   |
|-----------|---------------------------------------------------------------|
| 9300-4200 | 1-1/4" x 1-1/4" x 48" hardwood oak (50/bundle)                |
| 9300-4400 | 1" x 1" x 18" mixed species stake (50/bundle)                 |
| 9300-4450 | 1" x 1" x 24" mixed species stake (50/bundle)                 |
| 9300-4460 | 1" x 1" x 36" mixed species stake (50/bundle)                 |
| 9300-4500 | 1" x 2" x 12" mixed species stake (50/bundle) - special order |
| 9300-4540 | 1" x 2" x 18" mixed species stake (50/bundle)                 |
| 9300-4545 | 1" x 2" x 18" notched stake mixed species (50/bundle)         |
| 9300-4550 | 1" x 2" x 24" mixed species stake (50/bundle)                 |
| 9300-4555 | 1" x 2" x 24" notched mixed species stake (50/bundle)         |
| 9300-4560 | 2" x 2" x 48" SPF stake (25/bundle)                           |
| 9300-4561 | 2" x 4" x 24" SPF wedge stake (50/bundle)                     |
| 9300-4563 | 2" x 2" x 60" SPF stake (25/bundle)                           |
| 9300-4565 | 2" x 2" x 72" SPF stake (25/bundle)                           |

## Tree Stakes

| SKU      | Description                           |
|----------|---------------------------------------|
| 24012015 | 1" x 2" x 12" redwood stake           |
| 24012025 | 1" x 2" x 18" redwood stake           |
| 24012040 | 8' x 1-1/2" treated square stake      |
| 24060610 | 6' x 2" tree stake Colorado           |
| 24060620 | 2" x 6' tree stake                    |
| 24060625 | 6' x 2" treated tree stake            |
| 24060815 | 8' x 2" tree stake - Florida          |
| 24060820 | 2" x 8' wood tree stake               |
| 24060825 | 2" x 8' treated wood tree stake       |
| 24060830 | 3" x 8' wood tree stake               |
| 24061020 | 2" x 10' wood tree stake              |
| 24061025 | 2" x 10' treated wood tree stake      |
| 24061030 | 3" x 10' wood tree stake              |
| 24061035 | 3" x 10' treated wood tree stake      |
| 24061050 | 12' x 2" treated tree stake           |
| 24061100 | 6" x 6" x 8' DSTK timber stake        |
| 24990071 | 10' x 4" Douglas fir tree stake       |
| 24990100 | 8' x 2" square tree stake 4-pnt       |
| 24990101 | 6' x 2" square tree STK 4-pnt         |
| 54004614 | 1" x 2" x 48" stake pointed           |
| 54004734 | 2" x 2" x 60" stake true safety fence |





## Recycled Landscape Edging Products + Accessories

Epic Plastics sets the standard in quality landscape edging products and are made exclusively from recycled plastics. Our products continue to be the professional landscaper’s choice for high-quality edging solutions and are widely used in the do-it-yourself market as well.

Epic Plastic’s commitment to our environment is crucial to our success and sets us apart from our competition. Our products are made from recycled plastic feedstock. Those milk, shampoo and laundry detergent bottles you put out on the curb for recycling are the materials that make Epic Plastic’s products.

We don’t stop at just recycling. We don’t burn fuels to make our products either. Epic Plastic’s equipment is powered by electricity and releases zero carbon emissions during the manufacturing process. Through 2021, our process has saved 200 million pounds of post-consumer plastic from landfills. All of Epic’s edging products are LEED approved, giving your project the boost it needs to go from Gold to Platinum certified.

### FEATURES

- Flexible and consistent, supporting geometric to complex designs
- Quick and easy installation with minimal cleanup required
- Durable and reusable generating value job after job
- Stable pricing and readily available
- Environmentally friendly
- Raw materials sourced and all our products are manufactured in the U.S.
- Made from recycled material

### APPLICATIONS

- Landscape edging
- Synthetic turf anchoring
- Concrete forms
- Pool edging guide
- Accurate tile/coping installation
- Geogrid edging
- Paver restraint/installation guide

| SKU       | Description                                                      |
|-----------|------------------------------------------------------------------|
| 100036729 | Benda Board redwood 1420 - actual: 1.82 cm x 8.5 cm x 6.04 m     |
| 100036733 | Benda Board sand 1420 - actual: 1.82 cm x 8.5 cm x 6.04 m        |
| 100059386 | Benda Board teak 1420 - actual: 1.82 cm x 8.5 cm x 6.04 m        |
| 100051993 | Benda Board black 1420 - actual: 1.82 cm x 8.5 cm x 6.04 m       |
| 100036731 | Benda Board redwood 2420 - actual: 3.47 cm x 8.63 cm X 6.04 m    |
| 100059389 | Benda Board teak 2420 - actual: 3.47 cm x 8.63 cm X 6.04 m       |
| 100036730 | Benda Board redwood 1620 - actual: 1.65 cm x 13.58 cm x 6.04 m   |
| 100059387 | Benda Board teak 1620 - actual: 1.65 cm x 13.58 cm x 6.04 m      |
| 100082778 | Benda Board black 1620 - actual: 1.65 cm x 13.58 cm x 6.04 m     |
| 100036732 | Benda Board redwood 2616 - actual: 3.42 cm x 13.71 cm x 4.82 m   |
| 100041851 | Epic Edge carmel brown 420 - actual: 1.40 cm x 8.5 cm x 6.09 m   |
| 100036756 | Epic Edge carmel brown 620 - actual: 1.40 cm x 13.58 cm x 6.09 m |
| 100060052 | Edge EX black tube edging - actual: 2.84 cm x 13.2 cm x 6.09 m   |
| 100048028 | Synthetic Turf Edge - actual: 3.81 cm x 3.81 cm x 3.65 m         |
| 100036740 | Standard stake redwood - actual: 1.7 cm x 29.84 cm x 3.5 cm      |
| 100036741 | Standard stake redwood - actual: 1.7 cm x 45.08 cm x 3.5 cm      |
| 100036742 | Standard stake sand - actual: 1.7 cm x 29.84 cm x 3.5 cm         |
| 100046315 | Standard stake carmel brown - actual: 1.7 cm x 29.84 cm x 3.5 cm |
| 100078300 | Standard stake black - actual: 1.7 cm x 29.84 cm x 3.5 cm        |
| 100082779 | Standard stake black - actual: 1.7 cm x 45.08 cm x 3.5 cm        |
| 200079367 | Redwood steel J stake 1x - actual: 3.42 cm x 32.38 cm x 3.25 cm  |
| 200079370 | Redwood steel J stake 2x - actual: 3.81 cm x 27.94 cm x 4.44 cm  |
| 200079371 | Sand steel J stake - actual: 3.42 cm x 32.38 cm x 3.25 cm        |
| 200102712 | Black steel J stake - actual: 3.42 cm x 32.38 cm x 3.25 cm       |
| 200102648 | Teak predrilled stake - actual: 1.7 cm x 29.84 cm x 3.5 cm       |
| 200102649 | Teak predrilled stake - actual: 1.7 cm x 45.08 cm x 3.5 cm       |
| 200079368 | Steel hairpin 1x - actual: 3.5 mm x 33.02 cm x 3.17 cm           |
| 200079369 | Steel hairpin 2x - actual: 4 mm x 29.84 cm x 4.57 cm             |
| 200079375 | #6 galvanized screws - 1-1/4"                                    |
| 200079376 | #6 galvanized screws - 2"                                        |





## Duraedge

Our landscape edging is made of high-quality, made-in-the-USA steel. It is available in a durable powder-coated finish, hot-dipped galvanized, unpainted or our new rusted finish. The J D Russell Company uses an exclusive shot blast preparation process before applying an ASTM-compliant powder coat for a durable, long-lasting finish.

### FEATURES

#### Unique three-stage powder-coat prep system

- Step 1: Edging is run through a detergent prewash to remove oil and grease from the manufacturing process
- Step 2: Edging is processed through a shot blasting machine which removes debris, rust and etches the surface of the steel for proper powder-coat adhesion
- Step 3: Edging is powder coated using high-quality, TGIC-durable powder coating that is compliant with ASTM standards

#### Uses For Duraedge

In addition to being an attractive, durable separator between landscape medias, Duraedge has other time- and money-saving uses.

- Concrete Forming
  - Duraedge can be used as a convenient, time-saving alternative to wood forms for concrete work
  - Easily create custom curves for sidewalks with less effort than traditional forms – just form, pour and leave edging installed or remove it to reuse it
- Paver Edging
  - Duraedge is strong enough to support pavers at their edge creating clean, even lines and requires no extended aggregate compaction

### SPECIFICATIONS

Available in:

- 14 gauge, 12 gauge, 1/8", 3/16" or 1/4" thickness
- Lengths of 8', 10' and 16'
- Custom sizes/custom layouts

### OPTIONS

- Available in multiple finish options: powder coated, galvanized, raw steel or self-weathering
- Available in standard straight edge or with a rolled top edge (14-gauge thickness only) for high foot traffic areas where safety is a concern

**Contact your local Ewing representative for more information and pricing.**





## Winter Products



Marking Stakes



Carrying Case



Installation Tools



## Ice Burner™ Treated

Ice Burner™ Treated is specially formulated to enhance the deicing performance of salt. This solution activates the deicing process immediately for quick and powerful removal of ice and snow.

- Effective to minus 20° range
- Superior lasting performance
- Color-coated purple for visual coverage
- Provides instant traction
- Prevents bonding of ice to walkway surfaces



| SKU     | Description                  |
|---------|------------------------------|
| 8708472 | Ice Burner™ Treated 50lb bag |

## Ice Burner™ Responsible

Ice Burner™ Responsible is specially formulated with PG-99, to enhance the deicing performance of salt. The PG-99 solution activates the deicing process immediately for quick and powerful removal of ice and snow. Ice Burner™ Responsible has been designed to provide instant traction control and corrosion inhibitors have also been added for enhanced safety.

- Effective to minus 20° range
- Enriched with PG-99 solution and CMA
- Less harmful to vegetation\*
- Pet-friendly choice
- Provides immediate and response-extended melt life
- Color-coated green for visual coverage

\*When used as directed



| SKU     | Description                       |
|---------|-----------------------------------|
| 8708572 | Ice Burner™ Responsible 50-lb bag |

## Ice Burner™ Ultimate

Ice Burner™ Ultimate is premium ice melter, formulated with calcium chloride and PG-99 solution to activate the deicing process immediately for quick and powerful removal of ice and snow. Ice Burner™ Ultimate performs at extremely low temperatures, minus 30° range.

- Effective to minus 30° range
- Enriched with calcium chloride
- Exceptionally fast-acting formulation
- Superior lasting performance
- Provides immediate response
- Color-coated blue for visual coverage



| SKU     | Description                    |
|---------|--------------------------------|
| 8708672 | Ice Burner™ Ultimate 50-lb bag |

**ULTRAVIOLET**

## Ultraviolet Inc. Ice Melt

### FEATURES

- Lab tested
- More effective than rock salt with less tracking and dust
- Creates instant traction
- Ideal for residential and commercial application
- Purple, organic non-staining dye for controlled application
- With proper application not harmful to vegetation
- Pet and environmentally friendly
- Safer on concrete

### SPECIFICATIONS

- 49 50-pound bags per pallet
- Pallet dimensions: 40" (W) x 48" (L) x 36" (H)
- Pallet weight: 2,500 lbs.

## Purple Heat

Purple Heat, the original, bestselling "Purple Stuff" is an 8% magnesium chloride and solar salt blend. It effectively melts ice and snow in frigid temperatures as low as minus 15°F / minus 26°C. Purple Heat creates instant traction and minimizes the accumulation of snow and ice during and after storms and can be used to prevent snow from sticking and ice from forming. It contains a purple, organic non-staining dye for controlled application. Purple Heat is safe on concrete and is pet and environmentally friendly with suggested application.



| SKU      | Description                 |
|----------|-----------------------------|
| 55105130 | Purple Heat ice melt pallet |

## Bulk Coarse Solar Salt

This dried and screened solar salt is white crystalline sodium chloride harvested through natural solar evaporation processes from brines from the Great Salt Lake in Utah. It effectively melts snow and ice in temperatures as low as minus 7° F. The packaging of 2,500 or 2,000 lb. super sack with fork lift-friendly straps and bottom funnel provides ease of dispensing into large truck-mounted spreaders. A Clear Roads Qualified product and the choice of many municipalities.



| SKU      | Description          |
|----------|----------------------|
| 55990012 | 2,500 lb. super sack |

## Ice Crusher

Ice Crusher utilizes the exothermic melting power of calcium chloride. This 8% blend will quickly and effectively melt snow and ice in temperatures as low as minus 15°F / minus 26°C. It contains a purple, organic non-staining dye for controlled application. Ice Crusher is safe on concrete and is pet and environmentally friendly with suggested application.



| SKU      | Description                 |
|----------|-----------------------------|
| 55103120 | Ice Crusher ice melt pallet |

## Ultraviolet Snow & Ice Melt

Ultraviolet Snow & Ice Melt is an economical blend of all-natural snow and ice melting minerals. Effective in melting snow and ice in temperatures as low as minus 7° F. Ultraviolet Snow & Ice Melt can be applied before accumulation to prevent snow from sticking and ice from forming. With an organic, non-staining violet dye, application is visible even under inclement conditions. When used as directed, Ultraviolet Snow & Ice Melt is safe for concrete, landscape and pets.



| SKU      | Description                        |
|----------|------------------------------------|
| 55105115 | Ultraviolet Snow & Ice Melt pallet |

## FreezGard® CI Plus Liquid

### 30% magnesium chloride with corrosion inhibitors

Produced naturally from the Great Salt Lake, FreezGard® CI Plus is specially formulated for deicing and anti-icing. It reduces the need for sand and gravel and their associated spring cleanup. FreezGard® remains active (liquid) at cold temperatures while minimizing precipitates down to zero degrees Fahrenheit. A Clear Roads Qualified product and the choice of many municipalities.



### SPECIFICATIONS

- 275-gallon tote
- 40" (W) x 48" (L) x 46" (H)
- 3,150 lbs.

| SKU      | Description               |
|----------|---------------------------|
| 55990015 | FreezGard® CI Plus liquid |



## SRP Strip Light

The SRP strip light is ideal for illuminating stair ledges, outdoor patios, hardscape elements and more, making it the perfect way to grow any lighting business. The innovative design of the SRP strip light makes it far easier and convenient to install strip lighting – even for contractors who’ve never done it before. With everything included, they’ll never want to install strip lights the old way again.

### FEATURES

- Extruded silicone body reduces hot spots, produces soft light distribution and protects against harsh environments
- Two color temperature options offer a warm (2,700K) or soft (3,000K) look
- 12 VAC power ensures compatibility with any low-voltage lighting transformer
- 2" (51 mm) cutmarks for precision customization
- A high IP65 rating ensures dust-proof and water-resistant performance
- Optional aluminum channel flush mount simplifies installation on hardscape and under ledges
- Compatibility with Luxor® low-voltage CUBE lets contractors add zoning and dimming capabilities

### SPECIFICATIONS

**Width:** 0.6" (15 mm)

**Length:** 10' (3.1 m) or 40' (12.2 m)

**Height:** 0.6" (15 mm)

**Lamp:** Integrated LED

| SKU                 | Description                              |
|---------------------|------------------------------------------|
| SRP-10-W / SRP-10-S | SRP strip light                          |
| SRP-40-W / SRP-40-S | SRP strip light                          |
| 59272805            | SRP strip connectors                     |
| 59272806            | SRP channel mount for strip light 3 pack |
| 59272807            | SRP cutting tool                         |
| 59272808            | SRP hardscape mount                      |



## NP Up Light

The NP is our most versatile LED up light, and is engineered to accommodate all aspects of your up-lighting needs. By coupling the proper light intensity with one of the provided color filters, your designer can fine tune the NP to beautifully enhance every landscape feature.

### FEATURES

- Die-cast aluminum
- Two-layer marine-grade anodization and powder coat-finish
- Cree® integrated LEDs
- ProAim™ adjustability
- Color temperature filters
- Compatible with Luxor® technology
- Phase and PWM dimmable
- Input voltage: 10-15V

### SPECIFICATIONS

**Width:** 2.66" (68 mm)

**Height:** 8.38" (213 mm)

**L-Shroud:** 10.3" (262 mm)

**Lamp:** 3, 6, 9 LEDs

**Material:** Aluminum

**Finishes:** BZ, DG, WI, SB, FB, WG, FW, AL and SV

| SKU*       | Description |
|------------|-------------|
| NP-3LED    | NP up light |
| NP-3LED-LS | NP up light |
| NP-6LED    | NP up light |
| NP-6LED-LS | NP up light |
| NP-9LED    | NP up light |
| NP-9LED-LS | NP up light |
| NP-ZD      | NP up light |
| NP-ZD-LS   | NP up light |
| NP-ZDC     | NP up light |
| NP-ZDC-LS  | NP up light |

\*The finish type for the fixture will be placed at the end of the SKU. Ordering example: NP-3LED-BZ

## FXLuminaire



### NL Up/Down Light

Engineered to bridge the gap between indoor and outdoor lighting applications, the low-voltage NL up/down sconce provides a high-performance, bidirectional solution for lighting contractors, A/V integrators and hardscape designers alike. Wall-mounted, geometric square down light or up/down sconce in 3, 6, or 9 LED. Available in aluminum or brass construction. RGBW option available for use with Luxor® lighting control systems.

#### FEATURES

- At just 3.2" (81 mm) wide, it's ideal for standard 4" (25 mm) wooden posts, as well as rafters, metal beams and stone columns
- Up/down configuration can illuminate both upwards and downwards, creating more dynamic effects than the original NL down light
- Provides ambient lighting, framing, transition points, perimeter lighting, and accenting
- Compatible with Luxor® technology for zoning, dimming and color, with separate control of the up and down configurations
- Accommodates 3, 6, 9 or ZDC boards and is available in a range of finishes for maximum design flexibility

#### SPECIFICATIONS

**Width:** 3.2" (81 mm)

**Depth:** 3.3" (84 mm)

**Length:** 7.3" (185 mm)

**Lamp:** 3, 6, and 9 LEDs

**Material:** Aluminum

**Finishes:** BSAB, BSAT, CUAB, CUAT, CU, BS, BZ, DG, WI, SB, FB, WG, FW, AL and SV

| SKU*              | Description      |
|-------------------|------------------|
| NL-3LED-UD        | NL up/down light |
| NL-3LED-UD-CR     | NL up/down light |
| NL-ZD-3LEDT-UD    | NL up/down light |
| NL-ZD-3LEDT-UD-CR | NL up/down light |
| NL-ZD-6LED-UD     | NL up/down light |
| NL-ZD-6LED-UD-CR  | NL up/down light |
| NL-ZD-9LED-UD     | NL up/down light |
| NL-ZD-9LED-UD-CR  | NL up/down light |
| NL-ZDC-UD         | NL up/down light |
| NL-ZDC-UD-CR      | NL up/down light |

\*The finish type for the fixture will be placed at the end of the SKU. Ordering example: NL-3LED-UD-BZ



### M-PK Path Light

The ultra-modern M-PK path light combines the versatility of die-cast aluminum with minimalist aesthetics to complement a range of contemporary installations. The stylish M-PK path light adds elegance and sophistication to any project.

#### FEATURES

- Tamper-resistant features
- Die-cast aluminum
- Two-layer marine-grade anodization and powder coat finish
- Cree® integrated LEDs
- Compatible with Luxor® technology
- Phase and PWM dimmable
- Input voltage: 10-15V

#### SPECIFICATIONS

**Length:** 22.5" (572 mm)

**Depth:** 4.7" (119 mm)

**Width:** 2.2" (55 mm)

**Lamp:** 1 and 3 LEDs

**Material:** Aluminum

**Finishes:** BZ, DG, WI, SB, FB, WG, FW, AL and SV



| SKU*         | Description     |
|--------------|-----------------|
| M-PK-1LED    | M-PK path light |
| M-PK-ZD-1LED | M-PK path light |
| M-PK-3LED    | M-PK path light |
| M-PK-ZD-3LED | M-PK path light |
| M-PK-ZDC     | M-PK path light |

\*The finish type for the fixture will be placed at the end of the SKU.

Ordering example: M-PK-ZD-3LED-BZ



## Luxor® Controller

Luxor® is the most advanced and flexible low-voltage lighting control system on the market. In addition to incorporating zoning, dimming, and color into a single controller, Luxor® provides the ability to create up to 40 distinct themes, and comes preset with calendar-based programming, timed sunrise and sunset offsets, and dual 15V outputs. With the Luxor® Cloud app, you can adjust fixture intensity and color, create unique themes and fine-tune your color palette for special occasions – right from the palm of your hand.

### FEATURES

- Zoning, dimming and color control capabilities
- Up to 250 independently adjustable lighting groups
- Up to 40 custom themes for special celebrations
- Preset calendar-based programming
- Timed sunrise and sunset offsets
- Smart device app control
- Smart home compatible
- Remote site management

### SPECIFICATIONS

Width: 8" (203 mm)

Depth: 5" (127 mm)

Height: 13" (330 mm)

Models: 150 or 300 watts

Finishes: SS and M

| SKU        | Description       |
|------------|-------------------|
| LUX-300-SS | Luxor® controller |
| LUX-300-M  | Luxor® controller |



## DX Controller

The DX controller is an easy-to-program, low-voltage lighting transformer for customers with intermediate on/off lighting control needs. It's the only digital facepack-controlled transformer with astronomical timing and event-based programming capabilities pre-installed, so there is no need for plug-in accessories such as timers and photocells.

### FEATURES

- Digital facepack control with built-in astronomical timing
- External input option
- Event-based programming with timed offsets
- 150- and 300-watt models
- Multi-tap output (12V, 13V, 14V)
- Powder-coated galvanized steel and stainless-steel options
- UL-1838, UL-379 compliant

### SPECIFICATIONS

Width: 7.14" (181 mm)

Depth: 5.04" (128 mm)

Height: 11.4" (290 mm)

Models: 150 or 300 watts

Finishes: SS and M

| SKU       | Description   |
|-----------|---------------|
| DX-150-SS | DX controller |
| DX-150-M  | DX controller |
| DX-300-SS | DX controller |
| DX-300-M  | DX controller |



## Sollos Grab 'n Go



For all of your landscape lighting solutions

- Unmatched value, quality and warranty
- Grab 'n Go offers a systemization for ease of selling and winning more jobs
- Take the guess work out of estimating to spend more time bidding and installing lighting
- Scalable pricing format to determine product needs and costs quickly and easily
- Product mix offers flexibility of design, size of project and site demands
- Allows for a 5-year warranty on aluminum (TZ) and lifetime warranty on antique brass (AB)
- 20-year LED lamp warranty

## Sollos Integrated Transformer

Integrated transformer 120V

### FEATURES

- Integral photocell and timer to allow operation manually, automatically or on a timer
- Automatically turns lights on at dusk and off at dawn
- Resettable circuit breakers to prevent overloads and short circuits
- Plug-in ready
- Stainless-steel enclosure
- Backed by a two-year limited warranty
- Included in both Sollos textured bronze aluminum and antique brass Grab 'n Go



| SKU    | Description    |
|--------|----------------|
| 997014 | TR12SS-INT-120 |

## Sollos Contemporary Bullet

6.5" contemporary bullet with 8" stake

### FEATURES

- Die-cast aluminum
- Shipped with MR16BAB LED lamp
- UV-resistant powder coat, two silicone O-rings for watertight seal
- Includes two silicone-filled direct-burial wire nuts
- Gasketed and sealed knuckle to prevent water intrusion
- 8" ABS ground stake included
- Part of Sollos textured bronze aluminum Grab 'n Go



| SKU     | Description               |
|---------|---------------------------|
| 921363S | BCB065-TZ-MR16BAB/827/LED |

## Sollos Straight Hat

4" straight hat, 8" ground stake

### FEATURES

- Die-cast aluminum
- Shipped with JC3 2.5W IP65 LED lamp
- UV-resistant powder coat, two silicone O-rings for watertight seal
- Includes two silicone-filled direct-burial wire nuts
- 8" ABS ground stake included
- Part of Sollos textured bronze aluminum Grab 'n Go



| SKU     | Description                   |
|---------|-------------------------------|
| 913148S | PSH040-TZ-12-JC3/830/IP65/LED |

## Sollos Straight Hat

5.5" straight hat, 8" ground stake

### FEATURES

- Die-cast aluminum
- Shipped with JC3 2.5W IP65 LED lamp
- UV-resistant powder coat, two silicone O-rings for watertight seal
- Includes two silicone-filled direct-burial wire nuts
- 8" ABS ground stake included
- Part of Sollos textured bronze aluminum Grab 'n Go



| SKU     | Description                   |
|---------|-------------------------------|
| 915310S | PSH055-TZ-15-JC3/830/IP65/LED |

## Sollos Straight Hat

7.5" straight hat, 8" ground stake

### FEATURES

- Die-cast aluminum
- Shipped with JC3 2.5W IP65 LED lamp
- UV-resistant powder coat, two silicone O-rings for watertight seal
- Includes two silicone-filled direct-burial wire nuts
- 8" ABS ground stake included
- Part of Sollos textured bronze aluminum Grab 'n Go



| SKU     | Description                   |
|---------|-------------------------------|
| 915314S | PSH075-TZ-15-JC3/830/IP65/LED |



## Sollos Dome Hat

8.3" dome, 15" stem, 8" ground stake

### FEATURES

- Die-cast aluminum
- Shipped with JC3 2.5W IP65 LED lamp
- UV-resistant powder coat, two silicone O-rings for watertight seal
- Includes two silicone-filled direct-burial wire nuts
- Underside of 8.3" diameter hat is coated with white reflective paint for optimum output and diffusion
- 8" ABS ground stake included
- Part of Sollos textured bronze aluminum Grab 'n Go



| SKU     | Description                   |
|---------|-------------------------------|
| 915312S | PD0083-TZ-15-JC3/830/IP65/LED |

## Sollos Contemporary Bullet

6.5" contemporary bullet, 8" stake

### FEATURES

- Die-cast antique brass
- Shipped with MR16BAB LED lamp
- UV-resistant powder coat, two silicone O-rings for watertight seal
- Includes two silicone-filled direct-burial wire nuts
- Gasketed and sealed knuckle to prevent water intrusion
- 8" ABS ground stake included
- Part of Sollos antique brass Grab 'n Go



| SKU     | Description                |
|---------|----------------------------|
| 921322S | BCB065-AB-MR16-BAB/827/LED |

## Sollos Flood Light

Flood reflector, 8" ground stake

### FEATURES

- Die-cast aluminum
- Shipped with JC3/830/IP65 LED lamp
- Shipped with frosted tempered glass
- Include clear accessory lamp in box
- UV-resistant powder coat, two silicone O-rings for watertight seal
- Includes two silicone-filled direct-burial wire nuts
- 8" ABS ground stake included
- Part of Sollos textured bronze aluminum Grab 'n Go



| SKU     | Description                |
|---------|----------------------------|
| 995414S | FRF057-TZ-JC3/830/IP65/LED |

## Sollos Traditional Hat

4" traditional hat, 12" stem, 8" stake

### FEATURES

- Die-cast antique brass
- Shipped with JC3 2.5W IP65 LED lamp
- UV-resistant powder coat, two silicone O-rings for watertight seal
- Includes two silicone-filled direct-burial wire nuts
- 8" ABS ground stake included
- Part of Sollos antique brass Grab 'n Go



| SKU     | Description                   |
|---------|-------------------------------|
| 915445S | PTH040-AB-12-JC3/830/IP65/LED |

## Sollos Ledge Light

LED ledge light

### FEATURES

- Die-cast aluminum
- 0.6 W, 2700K LED
- UV-resistant powder coat, two silicone O-rings for watertight seal
- Includes two silicone-filled direct-burial wire nuts
- 8" ABS ground stake included
- Part of Sollos textured bronze aluminum Grab 'n Go



| SKU   | Description       |
|-------|-------------------|
| 99961 | LLA055-TZ/827/LED |

## Sollos Pendant Light

4.3" pendant light

### FEATURES

- Cast-brass housing
- Clear tempered lens
- Includes MR16 WFL 10W
- 16' stainless-steel hanger included
- Part of Sollos antique brass Grab 'n Go



| SKU     | Description                |
|---------|----------------------------|
| 943021S | HLS043-AB-MR16FL10/827/LED |



## Sollos Flood Reflector

Flood reflector 12VAC

### FEATURES

- Die-cast antique brass
- Shipped with JC3 2.5W IP65 LED lamp
- UV-resistant powder coat, two silicone O-rings for watertight seal
- Includes two silicone-filled direct-burial wire nuts
- 8" ABS ground stake included
- Part of Sollos antique brass Grab 'n Go



| SKU     | Description                |
|---------|----------------------------|
| 995410S | FRF057-AB-JC3/A30/IP65/LED |

## Sollos Deck Post Light

3.3" Deck post light

### FEATURES

- Die-cast antique brass
- Shipped with JC1/830/IP65 LED lamp
- Two silicone O-rings for watertight seal
- Includes two silicone-filled direct-burial wire nuts
- Dual set screws for secure and precise mounting
- Shock- and heat-resistant frosted tempered glass
- Silicone seal around lens prevents water intrusion
- Part of Sollos antique brass Grab 'n Go



| SKU     | Description       |
|---------|-------------------|
| 940023S | DPL033-AB-JC1/LED |

## Sollos Underwater Light

Underwater light 4.5W 10-15V 3000K

### FEATURES

- Cast-brass body and cap with large thumb screws
- High-impact tempered flat glass
- 25' 18/2 SJTW cord
- Shipped with 4.5W MR16 3000K (81067) LED
- Three-year warranty
- Part of Sollos antique brass Grab 'n Go



| SKU     | Description    |
|---------|----------------|
| 999998S | UWL-R33-AB-30K |

## Sollos Ledge Light

LED ledge light

### FEATURES:

- Die-cast antique brass
- 0.6W, 2700K LED
- UV-resistant powder coat, two silicone O-rings for watertight seal
- Includes two silicone-filled direct-burial wire nuts
- 8" ABS ground stake included
- Part of Sollos antique brass Grab 'n Go



| SKU   | Description       |
|-------|-------------------|
| 99980 | LLA055-AB/827/LED |



## Sollos ColorSplash® Product Family

ColorSplash® product family of bluetooth-controlled color-changing RGBW lamps and fixtures dazzle outdoor spaces

### FEATURES

- RGBW color-changing landscape lighting
- MR16, PAR36 and hardscape ledge light
- Bluetooth-controlled RGBW landscape lighting via free Apple and Android apps
- Easy-to-use app allows full range of color and white light control, dimming, timing functions and zone creation
- No Wi-Fi networks to deal with or additional wiring required
- Ability to set seasonal colored themes using landscape lighting
- Can easily retrofit into an existing installation

| SKU   | Description                          |
|-------|--------------------------------------|
| 82099 | MR16 FL6/RGBW/LED ColorSplash        |
| 82142 | PAR36WFL10/RGBW/IP68 LED ColorSplash |
| 27514 | ColorSplash Bluetooth repeater       |
| 27516 | LLA055-TB-RGBW GEN 2 TEXT BLK        |
| 27517 | LLA055-TZ-RGBW GEN 2 TEXT BRZ        |
| 27518 | LLA055-RGBW replacement module       |

## Holiday and Special Event Lighting



### Popular LED Light Strings

Create brilliant and dramatic holiday displays with rugged 5MM LED lights.

- Provide extraordinary brightness and reduced energy costs.
- Wide angle, conical concave lensing for 360 degrees of saturated color, casting light in every direction.
- Reduce tangling or bulging, resulting in a clean and polished appearance.
- Create a professional display with a low profile that hugs to the installation surface.
- Pre-balled packaging simplifies installation, reducing labor costs up to 30 percent.



## Experience the Ewing Advantage



### PROFESSIONAL GRADE PRODUCTS

Ewing sells professional grade lighting of uncompromising quality. Premium grade materials and consistent sourcing allow us to product match and color match year over year. Rather than contract lowest bid each year, Ewing sources from the same reliable factories we've worked with for many years. This commitment to consistency offers peace of mind to professionals building their business or adding to existing projects.

### BUY HOLIDAY LIGHTING AS YOU NEED IT

Ewing is committed to eliminating adverse risk to your business, with no minimum order amount and no case quantity requirement you are free to buy as needed. Maximize year end sales while minimizing opportunity costs and carry over. Ewing offers you a risk free Holiday opportunity, improved cash flow management and peace of mind during an uncertain business climate whether early order or late season.



### LARGE COMMITMENT TO INVENTORY ON HAND

High depth of stock investment coupled with multiple store stock strategy allow us to move inventory in and out of markets quickly in season. Our stock strategy allows Ewing to offer a local source for Holiday lighting both in season as well as throughout the entire calendar year. Availability will vary year to year.

### LOCAL CONNECTIONS

Ewing offers credit terms, cash account rebates and unparalleled customer service- providing value on line sellers cannot. We sell what you need when you need it, offer delivery options to the job site and allow returns on Holiday through December 1st. We have the ability to help you find and source special order requests in season, partnering with importers across the country. We are the local supplier of goods and services - building reliable partnerships as we help you grow your business.

## Warm White 5mm LED String Lights

Lighting installers around the U.S. use Wintergreen lighting 5mm LED string lights for their holiday and event lighting displays. The patented sealed construction of Wintergreen's 5mms keeps water out of the bulbs making them both durable and reliable. The lighting lenses also use color-infused acrylic rather than being coated, which means the color won't chip, fade or scratch. Wintergreen's 5mm string lights also feature a concave lens, which produces a unique starburst crown halo of light around the lens that makes these sets not only colorful, but bright. If you're looking for vivid color, brilliant light halos and a highly durable lights, Wintergreen 5mm string lights are the choice for you.

### FEATURES

- Outdoor-rated, sealed construction
- Shatterproof light
- End-to-end connectable
- Stackable male plugs
- Fully rectified to eliminate flicker
- Twist-proof, non-removable bulbs
- Cool to the touch
- Available in multiple colors and lengths
- If one light goes out, the rest stay lit

### DIMENSIONS

- 70 ct. lights, 23 ft., with 4" spacing
- 50 ct. lights, 25 ft., with 6" spacing

### OPERATING SPECIFICATIONS

- 2.4 watts per set or 4.8 watts per set
- End-to-end connectable up to 216 watts

| SKU      | Description                                         |
|----------|-----------------------------------------------------|
| 29553070 | 70 ct. warm white 5mm LED string lights, green wire |
| 29553770 | 50 ct. warm white 5mm LED string lights, green wire |

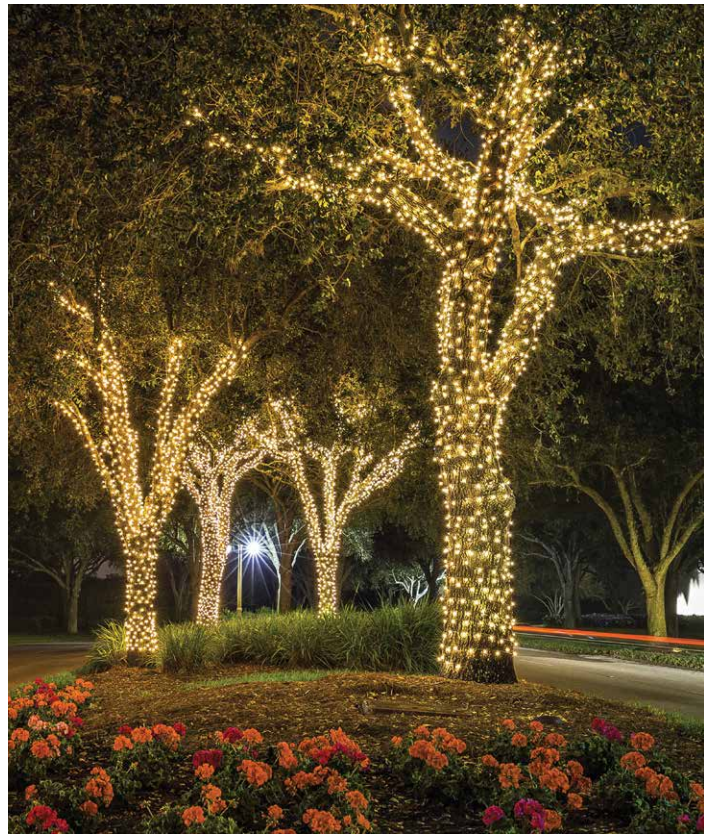

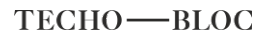

## Hardscapes

segmental walls/caps • pavers and permeable pavers • outdoor living kits • hardscape accessories

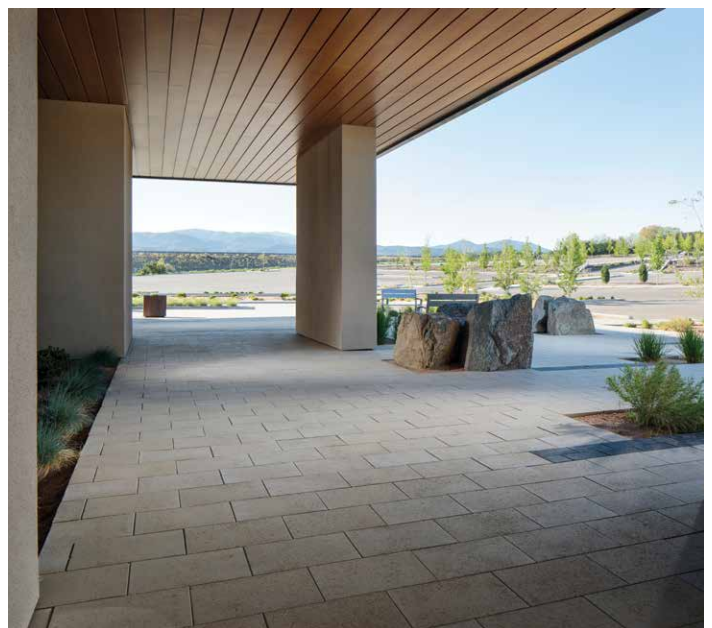

Contact your local Ewing representative for information and pricing. Product color and availability may vary by location.

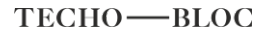

# Hardscapes

segmental walls/caps • pavers and permeable pavers • outdoor living kits • hardscape accessories

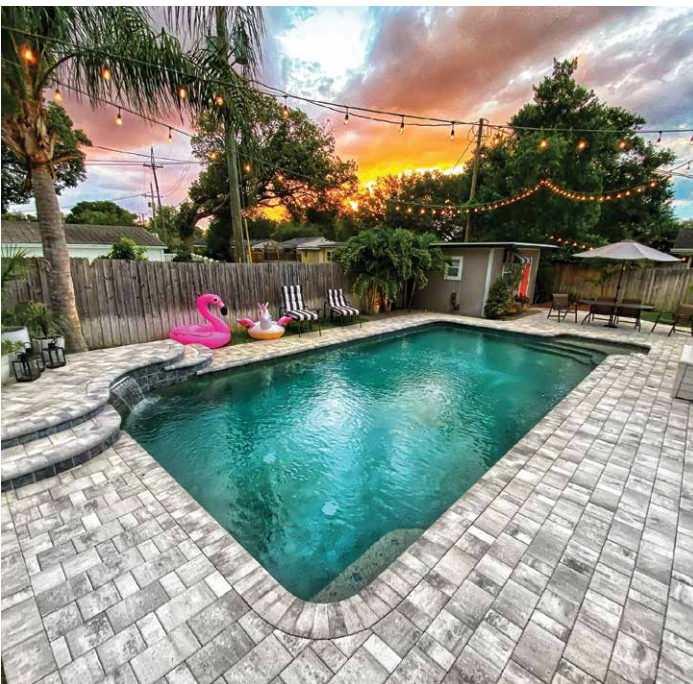
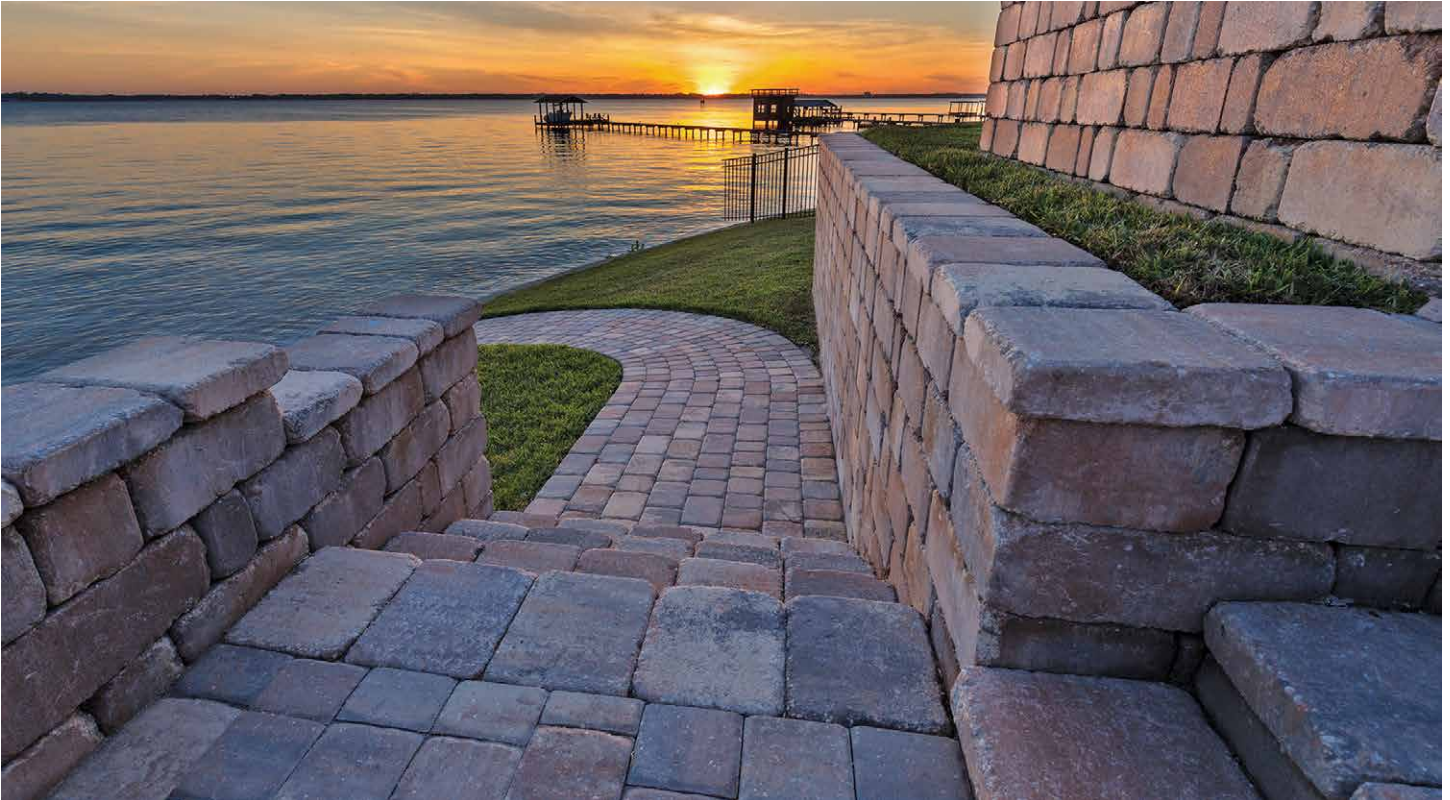

Contact your local Ewing representative for information and pricing. Product color and availability may vary by location.



## Hardscapes

segmental walls/caps • pavers and permeable pavers • outdoor living kits • hardscape accessories

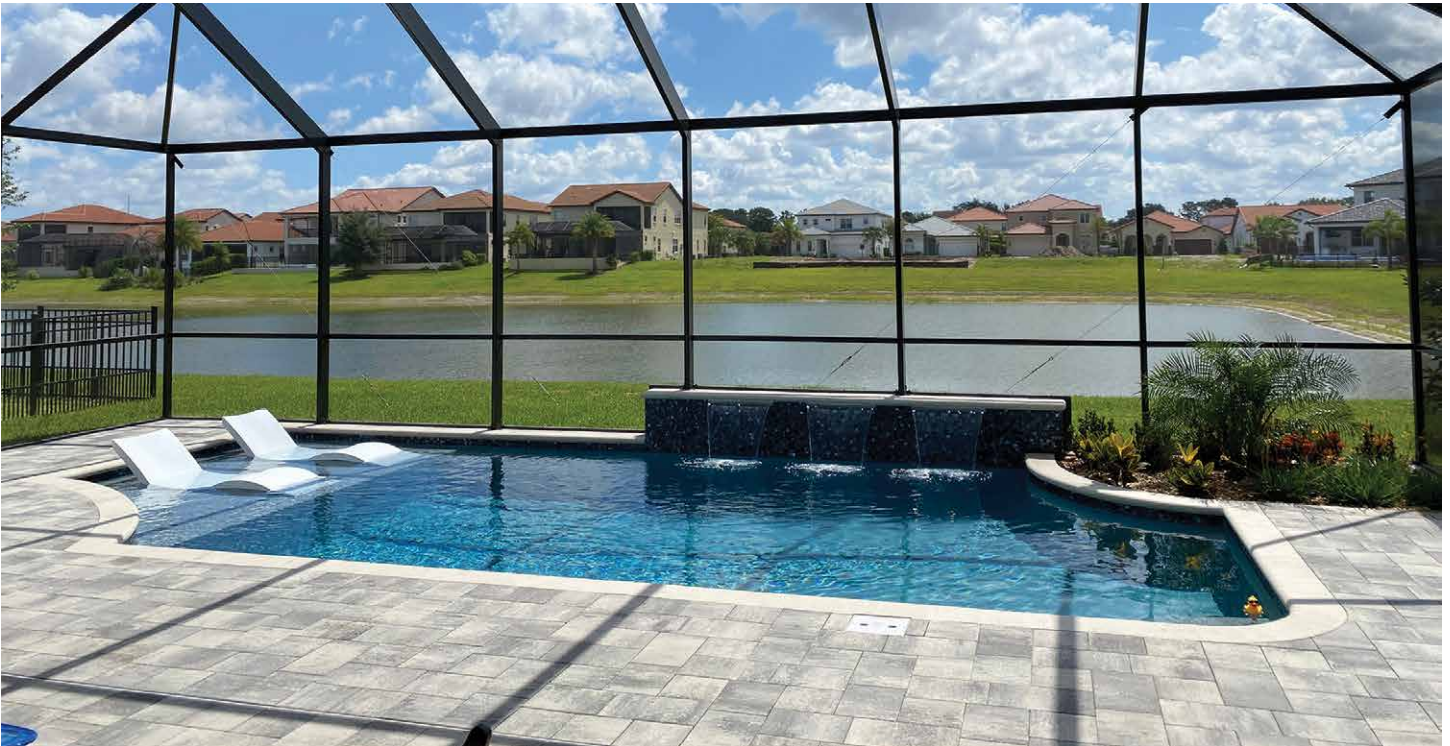

Contact your local Ewing representative for information and pricing. Product color and availability may vary by location.





## Synthetic Turf



| SKU      | Description                    |
|----------|--------------------------------|
| 24100800 | EPS Supreme II 15ft wide CSTM  |
| 24100920 | EPS Pet Turf II 15ft wide CSTM |
| 24100110 | EPS Supreme Dark 15ft CSTM NW  |
| 24100840 | EPS Pro II 15ft CSTM           |
| 24100820 | EPS Premium II 15ft wide CSTM  |
| 24100870 | EPS Classic III 15ft CSTM      |
| 24100880 | EPS Golf II putting green 15ft |

## Synthetic Turf Supplies



| SKU      | Description                    |
|----------|--------------------------------|
| 24101600 | EPS 50# emerald fill plus sand |
| 24101000 | EPS Turf Seam kit w/glue 30ft  |

## Disclaimers

- **Rain Bird golf territory**  
Rain Bird golf products are sold in exclusive Ewing Rain Bird golf territories only.
- **Freight charges may apply to orders**
- **Not all items can be delivered due to size and weight constraints**
- **Some items may not be available in all territories.**
- **Some items require a minimum quantity for orders**

### RAIN BIRD GOLF TERRITORIES

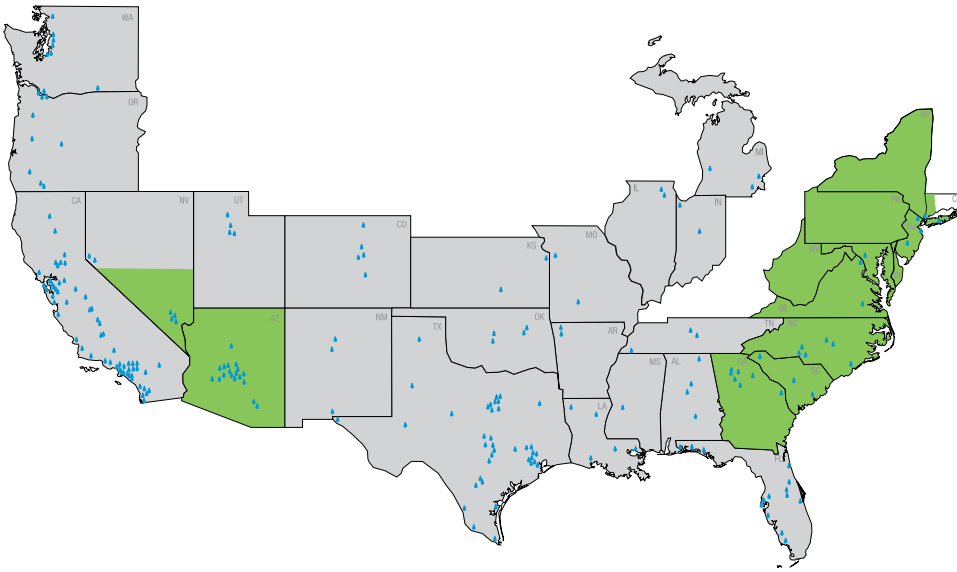

**The Best Conditions Require the Best Partners.**  
***LEAN ON US!!!***

Scan the QR Code and let us  
know how we can help you.



Product availability varies by location. Scan the QR code for more information.





Ewing Outdoor Supply  
3441 E. Harbour Drive | Phoenix, AZ 85034  
Ewing Outdoor Supply.com

Copyright 2023 Ewing Irrigation Products, Inc. Ewing is a registered trademark of Ewing Irrigation Products, Inc.